



L Series

Grade 1 mortise locks

- Mechanical
- Wired electrified
- Wireless electronic
- Multi-point



The Schlage® L Series mortise locks

Security has always been at the heart of all our products. But, today we offer so much more. Since our beginning nearly 100 years ago, Schlage® has consistently delivered innovation and continuous improvement to the solutions you've grown to trust. And the L Series mortise locks are no exception.

Proven technology

The L Series is built to withstand the rigors of daily use without fail and is among the most durable, dependable and intelligent family of products on the market today. When you choose a Schlage lock you can have confidence you've chosen a solution that will provide protection at the most critical moments.

Comprehensive offering for every opening

Mechanical, wired electrified, wireless electronic and multi-point solutions allow a common aesthetic and consistent user experience throughout the building while lowering the total cost of ownership.

And, with an extensive list of functions, keying, trim, levers and finish options the L Series works for any application.



World-class style and design

Door hardware is both a functional component and an architectural element. All the more reason to select durable door hardware that can be suited across a facility—all the more reason to select Schlage along with other Allegion brands.

With an expansive selection of levers that are packed with style and durability, a lineup of finishes to enhance any environment, and options to suite with cylindrical and tubular locks and exit devices means that you have more choices that support your goals for aesthetic consistency throughout a room, a floor, or an entire facility.

Overview

Key features

Trims and finishes

Mechanical

Wired electrified

Wireless electronic

Multi-point

Key systems and credentials

Parts

Ordering and specifications

Mortise lock comparison

L mechanical

**Applications**

The Schlage L Series has long been the benchmark for mortise locks. Beyond strength and security – it offers tremendous flexibility to allow it to meet the needs of most every application.

The ability to suite across electronic, tubular, exit trim, and multi-point locks allows the Schlage L Series mortise lock to integrate seamlessly into any environment.

Key features

- Exceeds ANSI/BHMA Grade 1 operational and security standards
- Expansive list of configurations and options, including retrofit indicators
- 50 standard mechanical functions, custom functions also offered
- “The Original” universal lock case allows creation of 10 functions from a single lock body
- 14 finishes and 33 levers, two knobs, five roses and three escutcheon designs
- Supports standard, SFIC and FSIC cylinder formats
- Multiple key systems available – open, patented, restricted, geographic exclusive, UL 437

L wired electrified

**Applications**

The wired electrified L Series is ideal for new construction and high traffic areas where hardwired power ensures continuous operation and where electrified door prep, hinges and wiring can easily be incorporated into the building.

The electrified L Series is regularly used as part of an access control system for high security areas, or independently in areas that require a remote access switch.

Key features

All mechanical features plus:

- Auto-detect 12/24 VDC
- Selectable EL/EU
- 10 electrified functions
- Advanced features: RX, DPS, latchbolt monitor and deadbolt monitor for application flexibility
- Leading energy efficiency that eliminates “hot levers”
- Advanced motor-driven electrified functions – quieter, smoother, more secure operation

LE wireless electronic

**Applications**

The Schlage LE wireless mortise lock with ENGAGE™ technology is designed to affordably extend electronic access control deeper into the building beyond traditional perimeter and high security openings.

The LE is ideal for commercial real estate, K-12, higher education, assisted living, medical offices, or multi-family applications. Facilities can benefit from the enhanced security, efficiency, and convenience of upgrading to electronic credentials.

Key features

All mechanical features' plus:

- Six functions with LED indicator, deadbolt, and interior pushbutton options
- Sectional and escutcheon trim options
- 31 levers, 2 knobs and 9 finishes
- Integrated multi-technology card reader, door position sensor (DPS) and request to exit (RX)
- Built-in Bluetooth® enables wireless configuration from smart phones/tablets
- Built-in Wi-Fi® enables automatic daily updates sent directly from host software
- Capable of networked real-time communication with the ENGAGE Gateway and software alliances
- Up to 2 years of battery life

Mortise lock comparison

L400 mechanical



Applications

L400 Series locks are designed for use as primary locks where no latching is required, such as restrooms and small doors to utility spaces.

It also offers optimum security when used as an auxiliary lock in other applications.

Key features

- Six available functions
- 12 finishes
- 1" (25 mm) stainless steel throw deadbolt
- Deeper retainer groove in cylinder shell increases security against wrenching and pullout; all cylinders backward compatible
- 6-pin Everest® 29 cylinder with patented keys standard
- Steel case and parts are corrosion resistant

LM9200 multi-point

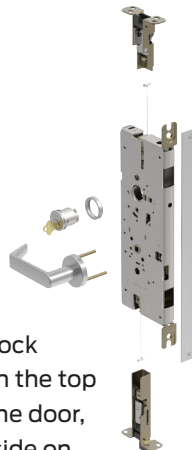

Applications

The Schlage LM9200 series lock utilizes latches in the top and bottom of the door, rather than the side on single or double sets of doors.

Compatible with wood or hollow metal doors, the LM9200 Series is ideal for conference rooms, corridors, office suites, elevator lobbies, and openings where flush bolts and coordinators are not desired.

Key features

- Concealed vertical cables provide simple installation and reliable performance
- Compatible with sectional and escutcheon trim; does not require "backer plates" or metal wraps for fire protection
- Fire-rated for up to 60 minutes for wood door applications; 90 minute fire rating for hollow metal door applications
- 33 lever designs
- 13 functions (mechanical and electrified)
- Available without the bottom latch for single point latching

LM9300 multi-point



Applications

The LM9300 Series is part of a three-point locking system designed for tornado, hurricane or high security applications, providing superior protection with familiar operation.

Latches at the top, side and bottom of the door provide protection from high wind speeds and 15-lb. projectile impacts up to 100 mph when paired with a Steelcraft Paladin tornado-resistant door.

Key features

- All three latches engage when the door is shut and retract simply by rotating the lever
- Compatible with sectional and escutcheon trim
- 33 lever designs
- Six available functions
- Complies with FEMA 361 and ICC500 tornado shelter guidelines and Florida Building Code Enhanced Protection Area (EHPA) standard when paired with appropriate Steelcraft doors
- Vertical rods ship pre-aligned and pre-installed with Steelcraft doors, enabling quick and simple installation

From mechanical to wired electrified to wireless electronic the L Series offers a grade 1 solution for the entire project.

L mechanical



Suitable for all openings

L wired electrified



Ideal for high-traffic access control

LE wireless electronic



Ideal for low-traffic access control

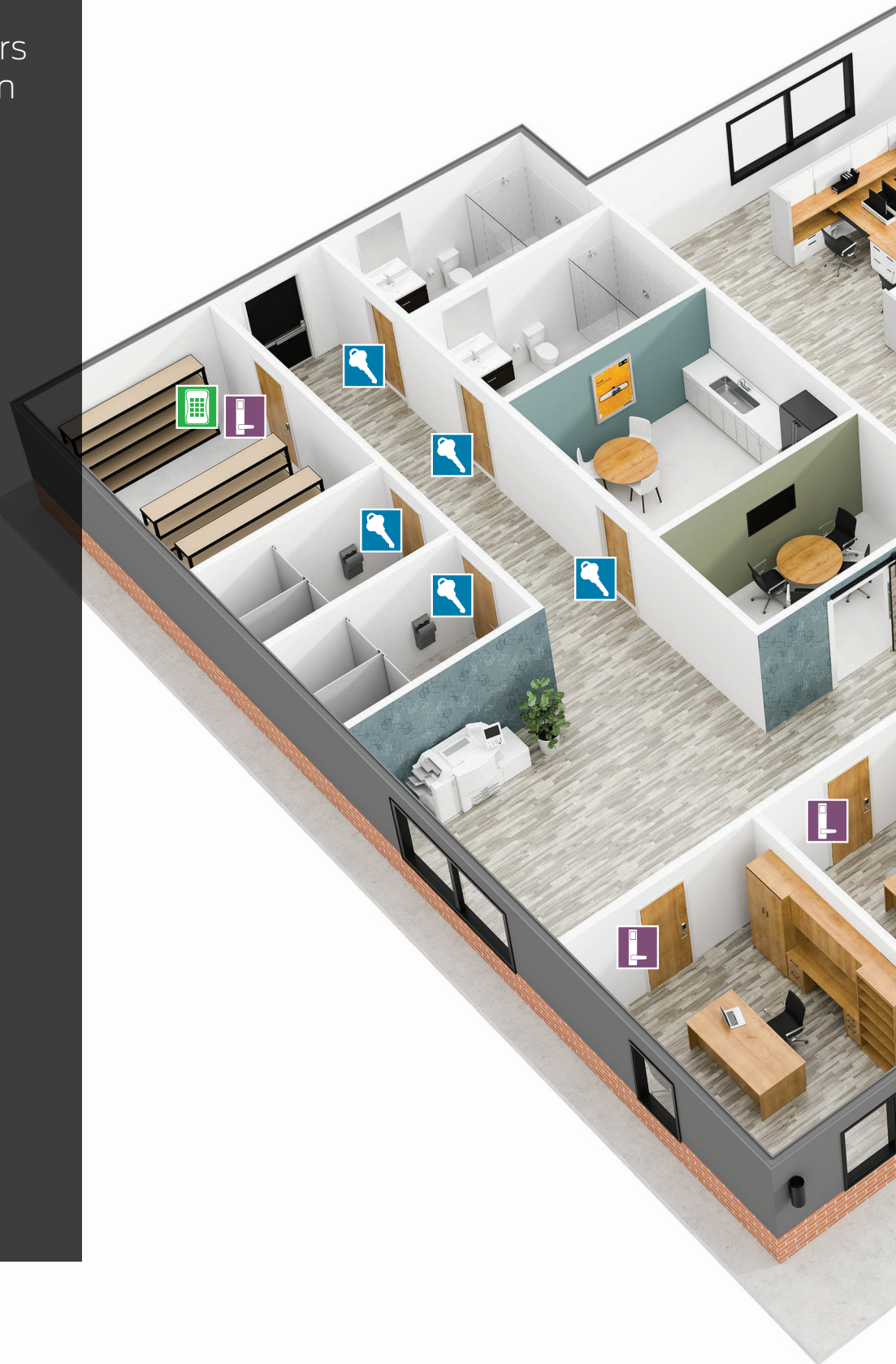





STRONG

The Schlage L Series has long been the benchmark for heavy-duty mortise locks.

- Exceeds Security Grade 1 and Operational Grade 1 ratings
- Every Schlage lock and deadbolt undergoes intensive testing to determine its ANSI grade level:
 - Cycle tests
 - Resistance tests
 - Door impact tests
 - Warped door tests
 - Bolt strength tests
- Levers constructed of solid brass or solid stainless steel for a strong-yet-comfortable feel
- Whether the application calls for high abuse resistance or just operation over millions of cycles without any degradation in performance, users can have confidence that the locks will last

SECURE

A strong lock is only part of the security equation—proper key and card access control is equally important.

- Everest 29™ cylinder with S123 keyway is provided standard which prohibits unauthorized key duplication at local stores; patent protected until 2029
- Dealer and end user restricted geographically exclusive Primus XP options for advanced key control
- SL cylinders are uniquely designed to accept the same Schlage A2 key system used in SFIC cylinders, enabling one key system to span three unique cylinder formats for better control
- Wired electrified and wireless electronic locks enable the use of electronic credentials for increased visibility and control over access
- Schlage smart credentials using MIFARE® DESFire® EV1 technology utilize encryption, mutual authentication and key diversification to ensure the highest levels of security



■ SMART

Smart means using innovation to make solutions more efficient, flexible, and easier to install and use.

- One platform, three solutions (mechanical, wired electrified, wireless electronic)—same look and feel throughout the building for a common user experience and lower cost of ownership
- Wired electrified lock has autodetecting 12/24V input and selectable EL/EU operation
- RX switch monitors the inside lever to balance security with lever actuation sensitivity
- Energy efficient design allows multiple locks on a single power supply with no "hot levers"
- Wireless electronic locks with ENGAGE™ can be managed with an access control system or with convenient ENGAGE web and mobile applications
- Wireless electronic locks provide the option to leverage existing network infrastructure for offline or real-time applications



More than just locks, Schlage delivers a complete portfolio and an infrastructure of support throughout the entire build and ownership process.

- From mechanical locks and keys to wireless electronic locks, readers and credentials, Schlage ensures you can create the most secure, efficient and convenient solution – all with a single brand
- Schlage products suite with other Allegion brands including Von Duprin® exit devices, LCN® door closers, Ives accessories and Steelcraft® doors and frames
- A trusted partner for nearly 100 years - consistently delivering proven and innovative solutions to serve the needs of our customers
- Comprehensive support from our sales offices including consultation, master key development and training; industry and code training, specification writing, and product service

A detailed look...

L mechanical

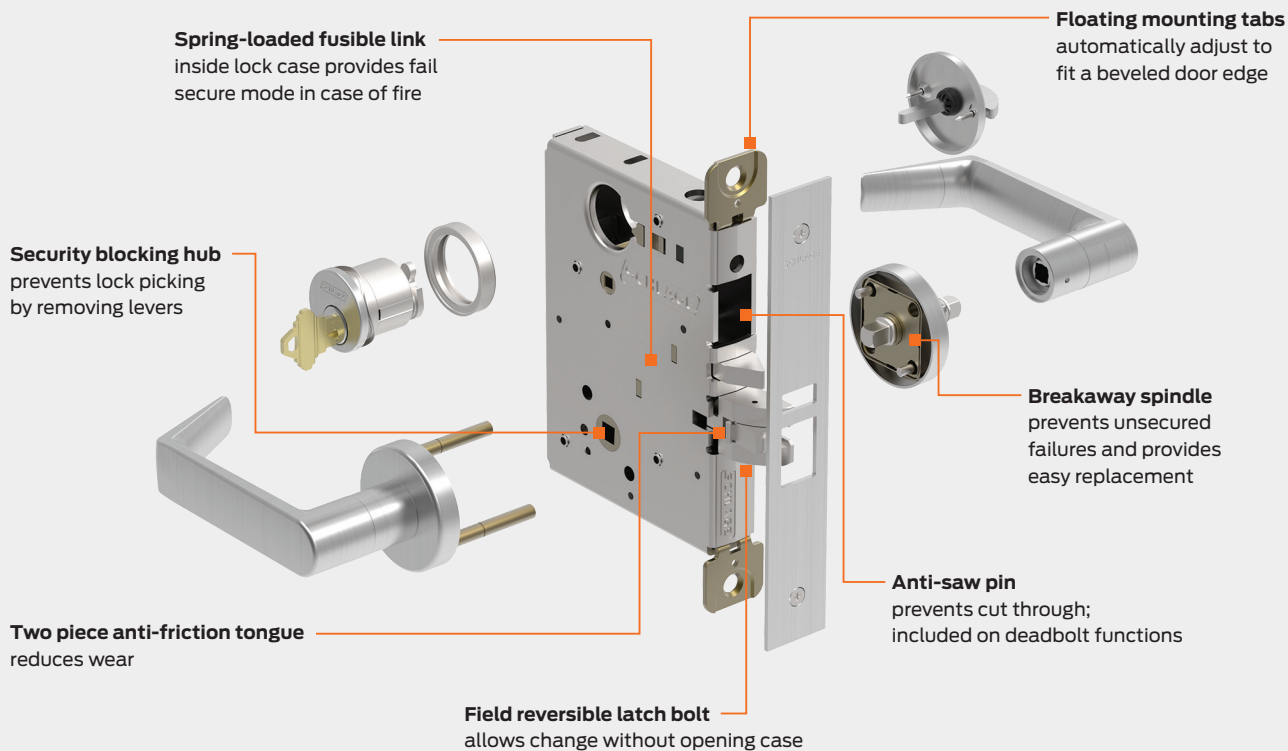

L wired electrified

All mechanical features +

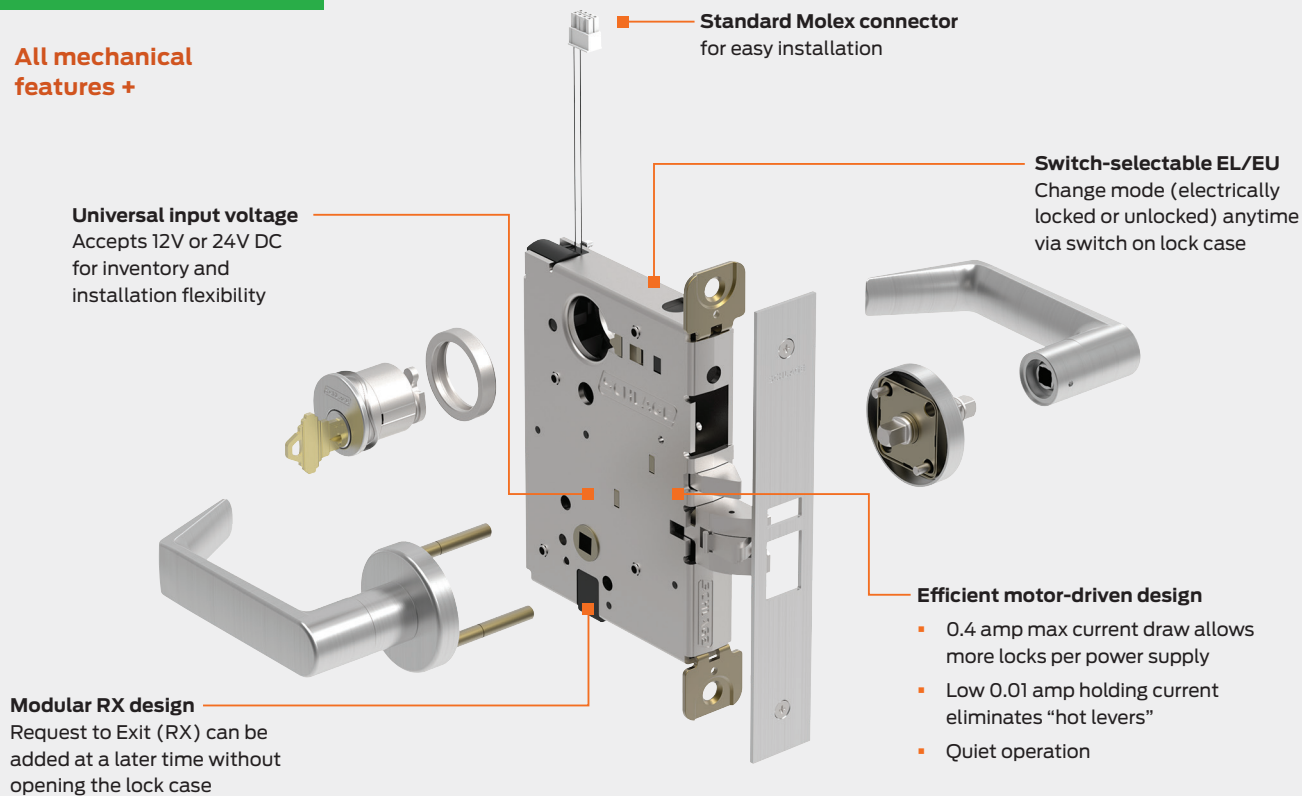

LE wireless electronic

Most mechanical features +

- Built-in Bluetooth®** enables wireless configuration from smart phones and tablets
- Built-in Wi-Fi** enables automatic updates to access rights
- Integrated multi-technology reader** reads both 125 kHz proximity and 13.56 MHz smart credentials
- Built-in No-Tour capability** eliminates the need to visit the locks by using smart credentials to update access rights
- Mechanical key override** compatible with most popular key systems
- Up to 2 years of battery life** with 4 AA batteries
- Integrated door position switch** requires no additional prep on MS and MB chassis options

LM9200 multi-point

- Fire protection** 90 min hollow metal door fire rating; 60 min wood door fire rating with metal wrap
- Concealed vertical cables** provide clean look and simple installation
- Top and bottom locking points** allow both leaves of a pair of doors to be active via switch on lock case
- Suites visually** with Schlage L Series and Von Duprin trim for design continuity

LM9300 multi-point

- Vertical rods ship installed and aligned** in Steelcraft doors, enabling quick and simple installation
- Flexible installation and removal of lock** can be done with door installed
- Three locking points** provide added layer of protection and security
- Suites visually** with Schlage L Series and Von Duprin trim for design continuity

Designs and finishes

The M Collection

The M Collection is an entire lineup of decorative levers designed to maintain a custom high-style look on doors throughout any building—from the main entrance to the supply closet. The ability to suite M Collection levers across multiple platforms from Schlage and Von Duprin means consistent style and functionality—along with unrivaled security.

M51

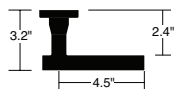

M52



M53

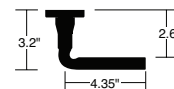

M54

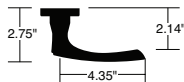

M55

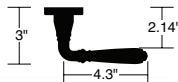

M56



M57^{1,2}



M61



M62^{1,2}

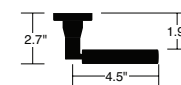

M63



M81



M82



Note: Shown with Schlage L Series mortise "A" rose. Additional rose and escutcheon designs available.

The M Collection

M83



M84

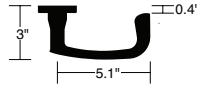

M85



ME1



ME2



ME3



Note: Images shown with Schlage L mortise 'A' rose; additional rose and escutcheon designs available.

1. Not available on LE wireless electronic locks.
2. Available in 630 and 630AM only.

Note: ME1, ME2 and ME3 ergonomic levers designed with Gensler as product design consultant.

All 18 of the M Collection designs can be paired with any of the following commercial graded products for suiting across an office, a floor, or an entire building.

Schlage locks



LT Series tubular locks / Grade 2

The perfect compliment to the Schlage L Series or the Von Duprin exit devices, the LT Series tubular chassis is based on venerable L Series mortise lock and provides an alternative for lever suiting interior doors.

Von Duprin exit devices



98/99 exit devices / Grade 1

Von Duprin created the first exit device in 1908, and continues to redefine the industry today with unsurpassed quality and industry-unique features such as concealed vertical cables. The 98/99 Series exit device is intended for standard-stile doors. Available on 996L trim only.



33A/35A exit devices / Grade 1

Offering the same innovative features as the 98/99 Series, the 33A/35A Series of exit devices is intended for narrow-stile doors. Available on 360L trim only.



94/95 exit devices / Grade 1

The 94/95 pushbar is recessed into the door to minimize the external profile, allowing more room for people and equipment to pass through. Available on 940L trim only.

Ives pulls and accessories

IVES / Grade 1

Finish the door opening with pulls and accessories that not only deliver exceptional quality, but provide a modern or elegant look depending on the architectural design.



Designs and finishes

The Standard Collection

The Standard Collection levers can be paired with exit devices and locks from our trusted Schlage and Von Duprin brands. And, they are built to the same exacting standards. Our Standard Collection levers offer a more traditional style that is appropriate for use in a number of commercial applications.

<p>01 ♿</p>		<p>02 ♿</p>		<p>03 ♿</p>	
<p>05 ♿</p>		<p>06 ♿</p>		<p>07 ♿</p>	
<p>12 ♿</p>		<p>17 ♿</p>		<p>18 ♿</p>	
<p>Accent ♿</p>		<p>Asti ♿</p>		<p>Latitude ♿</p>	

Note: Levers shown with Schlage L Series mortise "A" rose. Knobs shown with rose that is unavailable in the L Series. Additional rose and escutcheon designs available.

Designs and finishes

The Standard Collection

Longitude

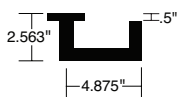

Merano

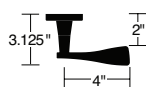

Omega

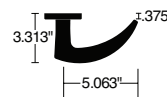

41



42

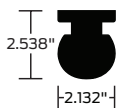

L Series finish options

Color	Bright brass	Satin brass	Antique bronze	Satin bronze	Oil rubbed bronze	Satin nickel	Matte black	Bright chrome	Satin chrome	Bright stainless steel	Satin stainless steel	Aged bronze
ANSI/BHMA	605	606	609	612	613	619	622	625	626/ 626AM	629	630/ 630AM	643e
US	US3	US4	US5	US10	US10B	US15	US19	US26	US26D	US32	US32D	US11
Mechanical	■	■	■	◆*	◆*	■	■	■	■	■**	■**	■
Wired electrified	■	■	■	◆*	◆*	■	■	■	■	■**	■**	■
Wireless electronic	■	■	■	◆*	◆*	■	■	■	■	■	■	■
Multi-point	■	■	■	◆*	◆*	■	■	■	■	■**	■**	■

◆ Standard levers only

* Not available on Latitude, Longitude, Accent, Asti, Merano

**Not available on Accent, Asti, Merano

Trim and special accessories

Escutcheons and roses

Three escutcheons and five roses are available to help to match the design and performance needed for your application.

Escutcheons



L full face

Specify by adding 'L' after lever design.

Material: Cold-forged brass, bronze or stainless steel

Finishes: 605, 606, 609, 612, 613, 619, 622, 625, 626, 629, 630, 643e

Size: 8" x 1 3/4" x 7/16"
(203 mm x 44 mm x 11 mm)



L concealed

Specify by adding 'C' suffix to function and by adding 'L' after lever design.

Material: Cold-forged brass, bronze or stainless steel

Finishes: 605, 606, 609, 612, 613, 619, 622, 625, 626, 629, 630, 643e

Size: 8" x 1 3/4" x 7/16"
(203 mm x 44 mm x 11 mm)



N full face

Specify by adding 'N' after lever design.

Material: Heavy wrought reinforced brass, bronze or stainless steel

Finishes: 605, 606, 609, 612, 613, 619, 622, 625, 626, 629, 630, 643e

Size: 8" x 2 9/16" x 7/16"
(203 mm x 65 mm x 11 mm)

Roses

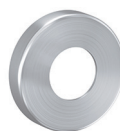

A rose

2 1/8" (54 mm) diameter
Available for use on L Series knob and lever designs. Specify by adding 'A' after lever design

Finishes: 605, 606, 609, 612, 613, 619, 622, 625, 626, 629, 630, 643e

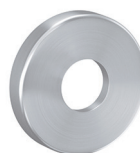

B rose

2 9/16" (65 mm) diameter
Available for use on L Series knob and lever designs. Specify by adding 'B' after lever design.

Finishes: 605, 606, 609, 612, 613, 619, 622, 625, 626, 629, 630, 643e

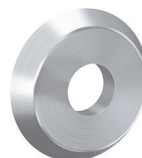

C rose

2 5/8" (66 mm) diameter
Available for use on L Series knob and lever designs. Specify by adding 'C' after lever design.

Finishes: 605, 606, 609, 619, 622, 625, 626, 629, 630, 643e

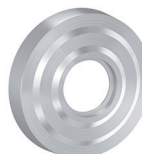

AVA rose

2 5/8" (66 mm) diameter
Available for use on ACC lever, other levers upon request.

Finishes: 605, 606, 609, 619, 622, 625, 626, 643e

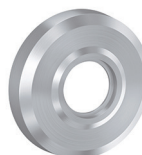

MER rose

2 5/8" (66 mm) diameter
Available for use on MER lever, other levers upon request.







Finishes: 605, 606, 609, 619, 622, 625, 626, 643e

Trim and special accessories

Thumbturns and indicators

Choose from these variations of thumbturn locks that help you meet the demands of specialized projects.

Thumbturns

					
Standard turn 09-509	ADA turn 09-509 x L583-363 Available with all thumbturn-function L Series locks except L9463 and L463	Coin turn L283-124 For lock functions L9044 and L9444 with rose trim.	Emergency button K510-330 For lock functions L9040 and L9440	Ligature resistant turn 09-029	Cylinder turn 09-90x For L463 and L9463 classroom function deadlocks

Indicators

The 180 degree visibility indicator offers unparalleled visibility and flexibility. The unique features of the indicator make it ideally suited for classroom security applications as well as traditional occupied/vacant applications.

- 2" x 1/2" display for easy viewing at a distance
- 180° window for visibility at any angle
- High-mount placement for quick assessment
- High contrast colors for ease of reading
- Available for over 30 functions, inside or outside of door (see Functions section for availability)
- Retrofit kit allows indicator upgrades to already installed L Series mortise locks
- Indicator text available in English or French

N escutcheon indicators

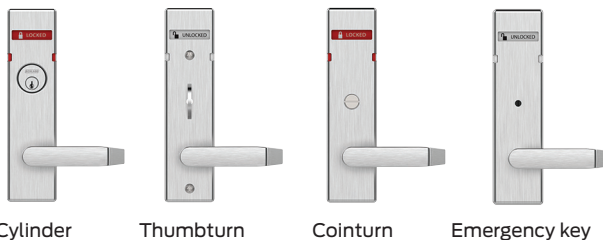





Cylinder Thumbturn Cointurn Emergency key

Sectional indicators



Cylinder Thumbturn Cointurn Emergency key

	 LOCKED	 OCCUPIED	 DO NOT DISTURB	 UNLOCKED
Inside trim	L283-711	L283-712	L283-713	L283-714
Outside trim	L283-721	L283-722	L283-723	L283-724

Legacy indicator



Hotel occupancy indicator

09-611

For lock function L9486P, used with A or B roses on section trim. Three available messages: "OCCUPIED", "DO NOT DISTURB" or "LOCKED".

Complementing locks and latches

HL6 quiet push/pull mortise lock

The HL6 push/pull latches are ideal for healthcare applications, restrooms, commercial and institutional doors. The short throw angle allows door opening with an easy push or pull action.

- Variety of vertical or horizontal mounting positions
- 16 mortise functions, including electrified
- 10 finishes, including antimicrobial options
- Quiet operation designed for healing environments
- Optional engraving on handles
- Available with lead lining
- ASA strike available
- Also available in tubular latching only or privacy models



Ligature resistant solutions

Specifically designed with multiple safety facets including recessed trim, sloped surfaces and concealed fastening hardware to reduce the risk of injury or death due to ligature strangulation in hospitals, behavioral health facilities and detention centers.

- Available with lever, knob, thumbturn and cylinder rings
- 25+ mortise functions, including electrified
- Available as a complete new lock assembly or as a conversion to an existing lock



SL1 lever



SK1 knob



LT Series decorative tubular locks

LT Series locks are built from the same foundational technology of the L Series mortise locks to provide durable, reliable performance and allow for a near seamless feel between the two types of locks. The LT Series seamlessly suites with the L Series by utilizing the same levers, finishes and roses to provide a consistent look and feel throughout the project.



Accessibility and life safety

Vandlgard®

The Vandlgard option is ideal for areas subject to abuse or anywhere vandalism is likely to be present. The outside lever rotates freely down when locked, limiting the ability of vandals to apply excessive force to the chassis which could damage internal lock components. Order available functions with the LV prefix.



Accessibility and life safety

Door hardware should be as effective in helping people go about their lives as it is in securing their environments. The Schlage L Series is designed with these requirements in mind.

Accessibility

All Schlage L Series levers comply with the Americans with Disabilities Act (ADA), which requires that “Operable parts shall be operable with one hand and shall not require tight grasping, pinching, or twisting of the wrist. The force required to activate operable parts shall be 5 pounds (22.2 N) maximum.”



Life safety

The Schlage L Series is UL listed for use on 3-hour fire doors (except L9076 and L9077).

All levers with returns comply with the California State fire code for return to within 1/2" of the door face.

Lead lined solutions

Lead lined locks are intended for use in X-ray or other rooms with radiation concerns. Add option XL11-515 (L9000) or XL12-216 (L400) on order.

Bullet resistant locks

The L9453P lock has been approved as a UL Listed Bullet Resistant Device (Levels 1, 2, and 3) when installed with other rated products to create a bullet resistant assembly.

Tactile warning for the visually impaired

Tactile warning is a special knurled surface used to alert the visually impaired to a potential hazard on the opposite side of the door (exit to street, a workshop or other hazardous areas). Tactile warning is typically applied to the outside lever only, and is specified by an 8 prefix on the lever number.

Available on 01, 02, 03, 05, 06, 07, 12, 17, 18, M51, M52, M81, ME1, ME2, ME3 lever designs

Milled



Milling pattern for backside of 01, 06, 07, 17 and 18 levers.

Knurled



Knurling pattern for 02 lever.

L Series mechanical locks

The Schlage L Series mechanical lock is the industry standard of mortise locks. It has earned its unparalleled reputation over its long history through consistently delivering reliable, durable and flexible performance.

The L Series not only exceeds ANSI/BHMA Security Grade 1 AND Operational Grade 1 standards, it also serves as the foundation for the Schlage L wired electrified, LE wireless electronic and multi-point mortise lock portfolios.

In addition to its strength and performance capabilities its 33 levers and 14 finishes allow seamless suiting across other Allegion lock styles and exit trim to create truly beautiful environments.

Features

- Exceeds ANSI/BHMA Grade 1 operational and security standards
- Expansive list of configurations and options
- 50 mechanical functions meet the requirements of most applications
- Universal lock case that supports 10 different functions
- 14 finishes paired with 33 levers, two knobs, five roses and three escutcheon designs to enhance any building style
- Levers constructed of solid brass or solid stainless steel for a strong-yet-comfortable feel
- Supports standard, SFIC and FSIC cylinder formats
- Multiple key systems available





Overview

Key features

Trims and finishes

Mechanical

Wired electrified

Wireless electronic

Multi-point

Key systems
and credentials

Parts

Ordering and
specifications

L Series mechanical lock functions

Legend

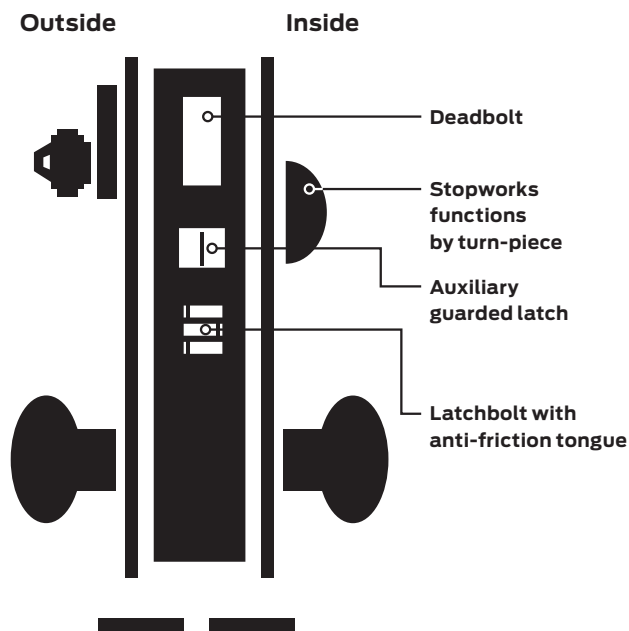

Key

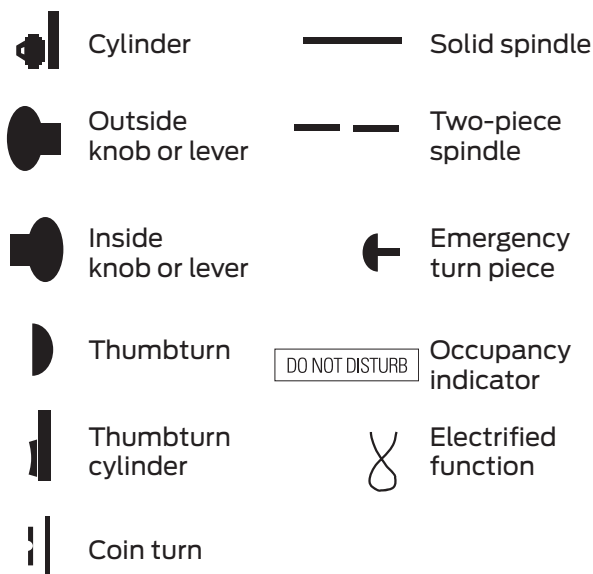

LV Vandlgard function allows exterior lever to rotate freely down, while remaining securely locked.





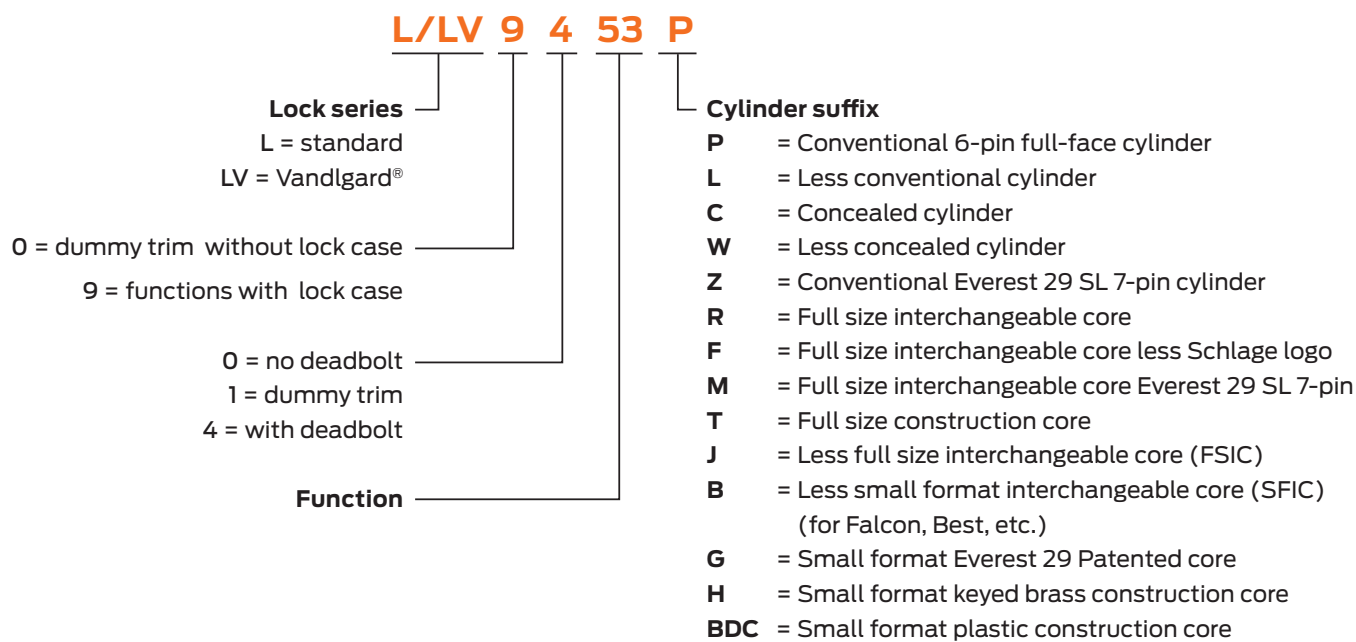

 180 degree messaging indicator available. See options section in price book for details.

Product identification guide





L Series mechanical lock functions

Non-keyed functions

Schlage	ANSI	Schlage	ANSI	Schlage	ANSI	Schlage	ANSI
L9010	F01	L9025	F31	L9040 LV9040	F22	L9044 LV9044	—
<p>Passage latch</p> <ul style="list-style-type: none"> • Latchbolt retracted by lever/knob from either side at all times • Inside lever always free for immediate egress 		<p>Exit lock</p> <ul style="list-style-type: none"> • No outside trim • Inside lever always free for immediate egress 		<p>Bath/bedroom privacy lock</p> <ul style="list-style-type: none"> • Latchbolt retracted by lever/knob from either side unless outside lever is locked by inside thumbturn • Actuating inside lever or closing door unlocks outside lever • To unlock from outside remove emergency button, insert emergency thumbturn in access hole and rotate • Inside lever always free for immediate egress 		<p>Privacy with coin turn outside</p> <ul style="list-style-type: none"> • Latchbolt retracted by lever/knob from either side unless outside lever is locked by inside thumbturn or outside coin turn • Actuating inside lever, closing door, or rotating outside coin turn unlocks outside lever 	
							
L9440 LV9440	F19	L9444 LV9444	—				
<p>Privacy with deadbolt</p> <ul style="list-style-type: none"> • Latchbolt retracted by lever/knob from either side • Deadbolt actuated by inside thumbturn • Throwing deadbolt locks outside knob/lever • Inside lever retracts both deadbolt and latchbolt and unlocks outside lever • To unlock from outside remove emergency button, insert emergency thumbturn in access hole and rotate • Inside lever always free for immediate egress 		<p>Privacy with deadbolt and coin turn outside</p> <ul style="list-style-type: none"> • Latchbolt retracted by lever/knob from either side • Deadbolt actuated by inside thumbturn or outside coin turn • Throwing deadbolt locks outside knob/lever • Inside lever retracts both deadbolt and latchbolt and unlocks outside lever • Rotating coin turn retracts deadbolt and unlocks outside lever • Inside lever always free for immediate egress 					
							

L Series mechanical lock functions

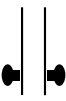





Non-keyed dummy functions

Schlage	ANSI	Schlage	ANSI	Schlage	ANSI	Schlage	ANSI
L0170	—	L0172	—	L9175	—	L9176	—
Half dummy trim		Full dummy trim		Half dummy trim with lock case		Full dummy trim with lock case*	
<ul style="list-style-type: none"> Fixed lever/knob on one side 		<ul style="list-style-type: none"> Fixed lever/knob on both sides 		<ul style="list-style-type: none"> Fixed lever/knob on one side Includes lock case and blank armor plate 		<ul style="list-style-type: none"> Fixed lever/knob on both sides Includes lock case and blank armor plate 	
							

*In a double-door application where the dummy will be used as the strike order 10-091 armored front strike separately.









L Series mechanical lock functions

Single cylinder non-deadbolt functions

<p>Schlage L9026</p> <p>Exit lock with cylinder</p> <ul style="list-style-type: none"> • No outside trim • Outside cylinder retracts latchbolt • Inside lever always free for immediate egress • Auxiliary latch deadlocks latchbolt when door is locked 	ANSI —	<p>Schlage L9050 LV9050</p> <p>Office and inner entry lock</p> <ul style="list-style-type: none"> • Latchbolt retracted by lever/knob from either side unless outside lever is locked by key or thumbturn • With outside locked, latchbolt retracted by key or inside lever • Outside lever locked until unlocked by thumbturn or key • Auxiliary latch deadlocks latchbolt when door is closed • Inside lever always free for immediate egress 	ANSI F04	<p>Schlage L9056 LV9056</p> <p>L9050 with automatic unlocking</p> <ul style="list-style-type: none"> • Latchbolt retracted by lever/knob from either side unless outside lever is locked by key or thumbturn • With outside locked, latchbolt retracted by key or inside lever • Outside lever locked until unlocked by thumbturn or key • Auxiliary latch deadlocks latchbolt when door is closed • Inside lever always free for immediate egress 	ANSI —	<p>Schlage L9070 LV9070</p> <p>Classroom lock</p> <ul style="list-style-type: none"> • Latchbolt retracted by lever/knob from either side unless outside lever is locked by key • Unlocked from outside by key • Auxiliary latch deadlocks latchbolt when door is closed • Inside lever always free for immediate egress 	ANSI F05
<p>Schlage L9076 LV9076</p> <p>Classroom holdback lock</p> <ul style="list-style-type: none"> • Latchbolt retracted by lever/knob from either side unless outside lever is locked by key • When locked, latchbolt retracted by key or inside lever • Auxiliary latch deadlocks latchbolt when door is closed • Holdback feature activated by turning inside lever/knob and rotating key 360° • Inside lever always free for immediate egress 	ANSI F06	<p>Schlage L9080 LV9080</p> <p>Storeroom lock</p> <ul style="list-style-type: none"> • Latchbolt retracted by lever/knob inside or key outside • Outside lever/knob is always inoperable • Auxiliary latch deadlocks latchbolt when door is closed • Inside lever always free for immediate egress 	ANSI F07	<p>Single cylinder deadbolt functions</p>		<p>Schlage L9453 LV9453</p> <p>Entrance lock</p> <ul style="list-style-type: none"> • Latchbolt retracted by lever/knob from either side unless outside locked by 20° thumbturn rotation • Deadbolt actuation through 90° thumbturn rotation • When locked, outside key or inside lever/knob retracts both deadbolt and latchbolt • Outside lever/knob locked until thumbturn is restored to vertical position • Throwing deadbolt locks outside lever/knob • Auxiliary latch deadlocks latchbolt when door is closed • Inside lever always free for immediate egress 	ANSI F20









L Series mechanical lock functions

Single cylinder deadbolt functions

Schlage	ANSI	Schlage	ANSI	Schlage	ANSI	Schlage	ANSI
L9456 LV9456	F13	L9465	—	L9473	F21	L9480 LV9480	—
Corridor lock		Closet/storeroom lock		Dormitory/bedroom lock		Storeroom lock with deadbolt	
<ul style="list-style-type: none"> Latchbolt retracted by lever/knob from either side Deadbolt actuation by key or thumbturn rotation Throwing deadbolt locks outside lever/knob Turning inside knob/lever retracts both deadbolt and latchbolt and unlocks outside lever/knob Inside lever always free for immediate egress 		<ul style="list-style-type: none"> Latchbolt retracted by lever/knob from either side Deadbolt actuation by key 		<ul style="list-style-type: none"> Latchbolt retracted by lever/knob from either side Deadbolt actuation by outside key or inside thumbturn 		<ul style="list-style-type: none"> Latchbolt retracted by outside key or inside knob/lever Outside knob/lever always fixed Deadbolt actuation by outside key or inside thumbturn Inside knob/lever actuation retracts both deadbolt and latchbolt Auxiliary latch deadlocks latchbolt when door is closed Inside lever always free for immediate egress 	
							
Schlage	ANSI	Schlage	ANSI	Schlage	ANSI	Schlage	ANSI
L9485 LV9485	—	L9486 LV9486	F15	L9486 x L583-375 LV9486 x L583-375	—	L9496	—
Faculty/hotel/restroom lock		L/LV9485 with 09-611 "DO NOT DISTURB" indicator for rose trim		L/LV9485 with "OCCUPIED" indicator for rose trim		Privacy with 09-611 "OCCUPIED" indicator for rose trim	
<ul style="list-style-type: none"> Latchbolt retracted by outside key or inside knob/lever Outside knob/lever always fixed Deadbolt actuation by thumbturn All keys (except emergency and display keys) inoperative when deadbolt is thrown Inside knob/lever retracts both deadbolt and latchbolt Auxiliary latch deadlocks latchbolt when door is closed Inside lever always free for immediate egress 		<ul style="list-style-type: none"> Latchbolt retracted by outside key or inside knob/lever Outside knob/lever always fixed Deadbolt actuation by thumbturn When deadbolt is thrown "DO NOT DISTURB" message is displayed and all keys (except emergency and display keys) become inoperative Inside knob/lever retracts both deadbolt and latchbolt Auxiliary latch deadlocks latchbolt when door is closed Inside lever always free for immediate egress 		<ul style="list-style-type: none"> Latchbolt retracted by outside key or inside knob/lever Outside knob/lever always fixed Deadbolt actuation by thumbturn When deadbolt is thrown "OCCUPIED" message is displayed and all keys (except emergency and display keys) become inoperative Inside knob/lever retracts both deadbolt and latchbolt Auxiliary latch deadlocks latchbolt when door is closed Inside lever always free for immediate egress 		<ul style="list-style-type: none"> Latchbolt retracted by knob/lever from either side Deadbolt actuation by outside key or inside thumbturn Thrown deadbolt displays "OCCUPIED" message and locks outside lever Inside knob/lever retracts both deadbolt and latchbolt and unlocks outside lever Inside lever always free for immediate egress 	
		 <small>DO NOT DISTURB</small>		 <small>OCCUPIED</small>		 <small>OCCUPIED</small>	

L Series mechanical lock functions









Double cylinder non-deadbolt functions

Schlage	ANSI	Schlage	ANSI	Schlage	ANSI	Schlage	ANSI
L9060 LV9060	F09	L9071 LV9071	F32	L9077 LV9077	—	L9082 LV9082	F30
Apartment entrance lock		Classroom security lock		Classroom security holdback lock		Institution lock*	
<ul style="list-style-type: none"> · Latchbolt retracted by knob/lever from either side unless outside is locked by key from inside · When locked, latchbolt retracted by outside key or inside knob/lever · Auxiliary latch deadlocks latchbolt when door is closed · Inside lever always free for immediate egress 		<ul style="list-style-type: none"> · Latchbolt retracted by knob/lever from either side unless outside is locked by key from either side · When locked, latchbolt retracted by outside key or inside knob/lever · Auxiliary latch deadlocks latchbolt when door is closed · Inside lever always free for immediate egress 		<ul style="list-style-type: none"> · Latchbolt retracted by knob/lever from either side unless outside is locked by key from either side · When locked, latchbolt retracted by outside key or inside knob/lever · Auxiliary latch deadlocks latchbolt when door is closed · Rotate inside lever/knob and turn key 360° to enable holdback feature · Inside lever always free for immediate egress 		<ul style="list-style-type: none"> · Latchbolt retracted by key from either side · Knob/lever on both sides always inoperative · Auxiliary latch deadlocks latchbolt when door is closed 	
							
Double cylinder deadbolt functions		Schlage	ANSI	Schlage	ANSI	Schlage	ANSI
		L9457 LV9457	F33	L9458 LV9458	F34	L9466	F14
		Classroom security lock with deadbolt		Classroom security lock w/ deadbolt and auxiliary latch		Store/utility room lock with deadbolt*	
		<ul style="list-style-type: none"> · Latchbolt retracted by lever/knob from either side · Deadbolt actuated by either key · Throwing deadbolt locks outside lever/knob · Actuating inside lever/knob retracts both deadbolt and latchbolt and unlocks outside lever · Inside lever always free for immediate egress 		<ul style="list-style-type: none"> · Latchbolt retracted by knob/lever from either side · Deadbolt actuated by either key · When door is locked outside lever inoperative · Inside lever retracts deadbolt and latchbolt and unlocks outside lever · Auxiliary latch deadlocks latchbolt when door is closed · Inside lever always free for immediate egress 		<ul style="list-style-type: none"> · Latchbolt retracted by knob/lever from either side · Deadbolt actuated by either key 	
							













* **Caution:** Double cylinder locks on residences and any door in any structure which is used for egress are a life safety hazard in times of emergency and their use is not recommended. Installation should be in accordance with existing codes only.

L Series mechanical lock functions

Mortise deadlock functions

Schlage L9460 Cylinder x thumbturn lock · Deadbolt actuated by key or thumbturn	ANSI F17	Schlage L9462 Double cylinder lock* · Deadbolt actuated by either key	ANSI F16	Schlage L9463 Classroom lock · Deadbolt actuated by key · Thumbturn retracts deadbolt but cannot extend it	ANSI F29	Schlage L9464 Cylinder lock · Deadbolt actuated by key · No trim opposite side	ANSI F18
 		 		 		 	









Small mortise deadlock functions

Schlage L460 Cylinder x thumbturn lock · Deadbolt actuated by key or thumbturn	ANSI E06071	Schlage L462 Double cylinder lock* · Deadbolt actuated by either key	ANSI E06061	Schlage L463 Classroom lock · Deadbolt actuated by key · Thumbturn retracts deadbolt but cannot extend it	ANSI E06091	Schlage L464 Cylinder lock · Deadbolt actuated by key · No trim opposite side	ANSI E06081
 		 		 		 	
Schlage L480 Door bolt · Deadbolt actuated by thumbturn · No trim opposite side	ANSI —	Schlage L496 Deadbolt with "OCCUPIED" indicator · Deadbolt actuated by key or thumbturn · When deadbolt is thrown "OCCUPIED" message is displayed	ANSI —				
 		 					

* **Caution:** Double cylinder locks on residences and any door in any structure which is used for egress are a life safety hazard in times of emergency and their use is not recommended. Installation should be in accordance with existing codes only.

L Series mechanical lock functions

Special functions









Schlage	ANSI	Schlage	ANSI	Schlage	ANSI	Schlage	ANSI
<p>L9110 x XL11-741</p> <p>Double dummy with active trim</p> <ul style="list-style-type: none"> Knobs/levers active Lock case and armor front included Can receive deadbolt with XL11-743 armor front 	—	<p>L9040 x XL11-446 LV9040 x XL11-446</p> <p>Privacy with turn both sides</p> <ul style="list-style-type: none"> Latchbolt retracted by either lever Rotating either thumbturn locks outside lever Actuating inside lever, closing door, or rotating either thumbturn unlocks outside lever 	—	<p>L9066 x XL11-897</p> <p>Storeroom lock*</p> <ul style="list-style-type: none"> Either key retracts latchbolt Either key locks or unlocks both levers 	—	<p>L9412 x XL11-907</p> <p>Exit lock with deadbolt</p> <ul style="list-style-type: none"> Latchbolt retracted by inside lever Outside lever always fixed Thumbturn actuates deadbolt Inside lever retracts deadbolt and latchbolt Auxiliary latch deadlocks latchbolt when door is locked 	—
<p>L9460 x XL11-635</p> <p>L9460 with fixed dummy trim</p> <ul style="list-style-type: none"> Both knobs/levers fixed Deadbolt actuation by key or thumbturn 	—	<p>L9460, L9462, L9464 x XL11-886</p> <p>Inside lever deadbolt retraction</p> <ul style="list-style-type: none"> L9460 x XL11-886 <ul style="list-style-type: none"> Deadbolt actuation by key or thumbturn Outside lever always fixed Inside lever active when deadbolt is thrown Inside lever retracts deadbolt L9462 x XL11-886 <ul style="list-style-type: none"> Same as L9460 except deadbolt actuated by key from either side L9464 x XL11-886 <ul style="list-style-type: none"> Same as L9460 except deadbolt actuated by key from one side 	—	<p>L9482 x XL11-543 LV9482 x XL11-543</p> <p>Institution lock with deadbolt*</p> <ul style="list-style-type: none"> Latchbolt retracted by either key Both levers always inoperative Deadbolt actuated by either key Auxiliary latch deadlocks latchbolt when door is locked 	—	<p>L9485 x XL11-557</p> <p>Prison function lock</p> <ul style="list-style-type: none"> Latchbolt retracted by outside key or inside knob/lever Outside knob/lever always free spinning Deadbolt actuation by guard key Inside knob/lever fixed when deadbolt is thrown Prisoner key only retracts latchbolt Tamper resistant Torx screws standard 	—

* **Caution:** Double cylinder locks on residences and any door in any structure which is used for egress are a life safety hazard in times of emergency and their use is not recommended. Installation should be in accordance with existing codes only.

L Series mechanical lock

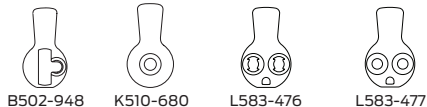





Universal transformation instructions

Instructions for base model L9050

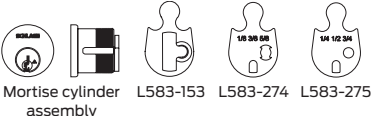
<p>Schlage ANSI</p> <p>L9050 F04</p> <p>Office with thumbturn Latchbolt operated by lever either side except when outside lever is made inoperative by a stop or other mechanical means other than key. When outside lever is locked, latchbolt is retracted by key from outside or by operating inside lever. Auxiliary deadlatch.</p>  <p>Transformation instructions Install cloverleaf cam cylinder on outside; install thumbturn assembly 09-509-027 on inside.</p> <p>No additional parts required.</p>	<p>Schlage ANSI</p> <p>L9010 F01</p> <p>Passage Latchbolt operated by lever from either side at all times.</p>  <p>Transformation instructions Do not install thumbturn unit 09-509-027 on inside or cylinder outside. Install chassis in the unlocked position.</p> <p>No additional parts required.</p>	<p>Schlage ANSI</p> <p>L9070 F05</p> <p>Classroom Latchbolt operated by lever either side except when outside lever is locked from outside by key or push button mechanism. When outside is locked latchbolt is retracted by key or by operating key or push button, and outside lever from outside or by operating inside lever. Auxiliary deadlatch.</p>  <p>Transformation instructions Install cloverleaf cam cylinder on outside; do not install thumbturn assembly 09-509-027 on inside.</p> <p>No additional parts required.</p>
<p>Schlage ANSI</p> <p>L9080 F07</p> <p>Storeroom Latchbolt operated by key outside or by operating inside lever. Outside lever always inoperative. Auxiliary deadlatch.</p>  <p>Transformation instructions Do not install thumbturn 09-509-027 on inside. Install chassis in the locked position. Replace cloverleaf cam L583-153 with straight cam B502-948 (Everest), L583-255 with K510-680 (IC and SFIC) and install on outside.</p> <p>Additional part(s) Cams B502-948 (Everest), K510-680 (IC and SFIC) or L583-476 or L583-477 for modular cylinders.</p> 	<p>Schlage ANSI</p> <p>L9060 F09</p> <p>Apartment entrance Latchbolt operated by lever either side, except when made inoperative by key from inside. When outside is locked latchbolt is retracted by key from outside or by operating inside lever. Auxiliary deadlatch.</p>  <p>Transformation instructions Do not install thumbturn 09-509-027 on inside. Install cloverleaf cam cylinder on inside. Replace clover leaf cam L583-153 with straight cam B502-948 (Everest), L583-255 with K510-680 (IC and SFIC) and install on outside.</p> <p>Additional part(s) Mortise cylinder assembly and cams B502-948 (Everest), K510-680 (IC and SFIC) or L583-476 or L583-477 for modular cylinders.</p> 	<p>Schlage ANSI</p> <p>L9025 F31</p> <p>Exit lock Latchbolt operated by inside lever. Non-removable blank trim or no trim outside.</p>  <p>Transformation instructions Do not install thumbturn unit 09-509-027 on inside. Install chassis in the locked position. Install inside lever with L285-150 mounting plate; do not install outside lever or cylinder.</p> <p>Additional part(s) Mounting plate L283-150.</p> 

Universal transformation instructions

Instructions for base model L9050

<p>Schlage ANSI</p> <p>L9071 F32</p> <p>Classroom security Latchbolt retracted by lever either side except when outside lever is locked by key from inside or outside. When outside lever is locked latchbolt is retracted by key either side or by inside lever. Auxiliary deadlatch.</p>  <p>Transformation instructions Do not install thumbturn unit 09-509-027 on inside. Install cloverleaf cam cylinder on inside and outside.</p> <p>Additional part(s) Mortise cylinder assembly and cam L583-153.</p> 	<p>Schlage ANSI</p> <p>L9026 —</p> <p>Exit lock with cylinder Latchbolt operated by key outside or by operating inside lever. No outside lever. Auxiliary deadlatch.</p>  <p>Transformation instructions Do not install thumbturn unit 09-509-027 on inside. Install chassis in the locked position. Replace cloverleaf cam L583-153 with straight cam B502-948 (Everest), L583-255 with K510-680 (IC and SFIC) and install on outside. Install inside lever with L283-150 mounting plate; do not install outside lever.</p> <p>Additional part(s) Cams B502-948 (Everest), K510-680 (IC and SFIC), mounting plate L283-150 or L583-476 or L583-477 for modular cylinders.</p> 	<p>Schlage ANSI</p> <p>L9080 —</p> <p>Utility (less inside trim) Latchbolt retracted by key outside; outside lever always inoperative. No inside trim. Auxiliary deadlatch.</p>  <p>Transformation instructions Do not install thumbturn unit 09-509-027 on inside. Install chassis in the locked position. Replace cloverleaf cam L583-153 with straight cam B502-948 (Everest), L583-255 with K510-680 (IC and SFIC) and install on outside. Install inside lever on outside with L283-150 mounting plate; do not install inside lever.</p> <p>Additional part(s) Cams B502-948 (Everest), K510-680 (IC and SFIC), mounting plate L283-150 or L583-476 or L583-477 for modular cylinders.</p> 
<p>Schlage ANSI</p> <p>L9070 —</p> <p>Closet (less inside trim) Latchbolt operated by lever on outside except when outside lever is locked from outside by key. When outside is locked latchbolt is retracted by key or by operating key from outside lever. Auxiliary deadlatch.</p>  <p>Transformation instructions Install cloverleaf cam cylinder on outside; do not install thumbturn assembly 09-509-027 on inside. Install inside trim on outside with L283-150 mounting plate.</p> <p>Additional part(s) Mounting plate L283-150.</p> 		

L Series wired electrified locks

The Schlage L Series wired electrified lock complements the L mechanical lock by working with access control systems to provide advanced security in high traffic areas. Because the electrified L uses a motor instead of a solenoid, it offers unparalleled energy efficiency, flexibility and quiet operation in wired electrified applications.

The electrified L also comes standard with an Allegion Connect Molex™ connector for simplified installation and maintenance.

Features

- Universal input voltage – accepts 12 or 24V DC for installation flexibility
- User selectable fail safe/fail secure – changing mode between EL and EU is as simple as flipping a switch on the lock case
- Low maximum current draw – 0.4amps - allows multiple locks on a single power supply
- Low holding current – 0.01 amps – produces minimal heat, eliminating “hot levers” in electrically locking applications and allowing reliable operation even in poorly ventilated wood doors
- All-new RX switch monitors the inside lever with enhanced detection level that balances security with lever sensitivity
- Modular RX design – RX can be added on at a later time without opening the lock case
- UL listed for 3 hour fire door



L Series wired electrified lock

Wiring, electrical requirements and options

Wiring diagrams

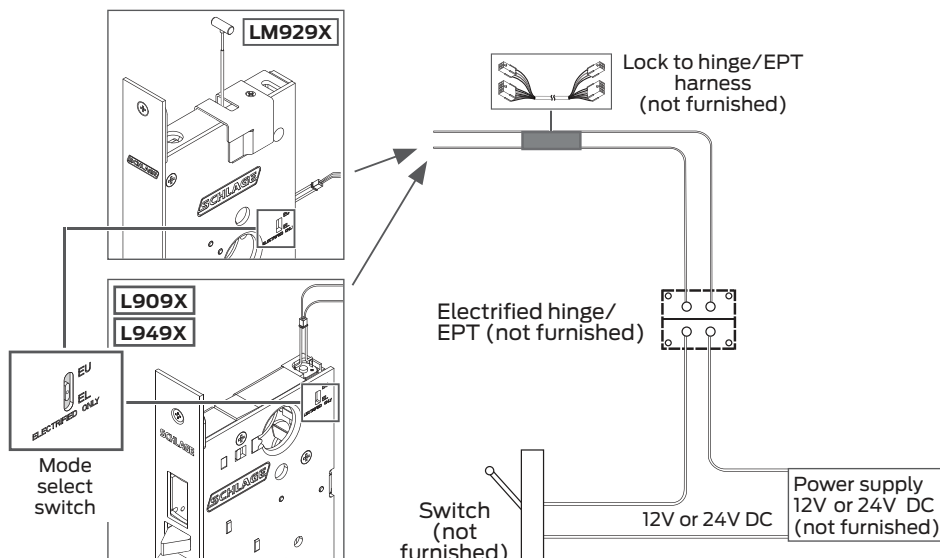

Electrical requirements

The L Series electrified locks are powered by DC power only. Do not use AC power. In addition to Allegion Connect connector, an extended-length molex-to-traditional terminal wiring harness is shipped with every lock.

- Voltage: 12V or 24V DC (maximum 26.4 V, minimum 10.8 V)
- Peak current: 0.4 amps
- Holding current: 0.01 amps
- Operating temperature: -22°F to 140°F (-30°C to 60°C)

Available options

- Request to Exit (RX)
- Latchbolt Monitor (LX)
- Door Position Sensor (DPS) - non-deadbolt functions only
- Deadbolt Monitor (DM) - deadbolt functions only





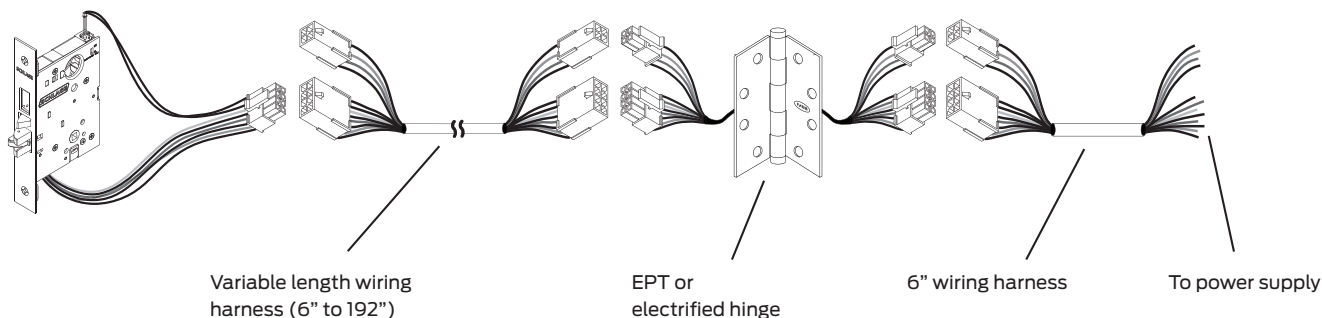

Allegion Connect

This factory-installed Molex connector system utilizes quick-connect harnesses and hinges for a quick and easy way to connect power sources; all the way from your power supply to electrified door hardware. Alternately, the connector can be cut off and the lock installed with traditional wire splicing methods. Note that the Allegion Connect harnesses and hinges are sold separately.







L Series wired electrified lock functions

All locks feature automatic detection and operation with 12V or 24V DC and a case-mounted switch that allows customer selection of EL (fail safe - power failure allows either knob/lever to retract latchbolt and/or deadbolt) or EU (fail secure - power failure locks both knobs/levers) operation. Please specify lock function as EL or EU for default switch position.

Schlage	ANSI	Schlage	ANSI	Schlage	ANSI
L9090EL L9090EU Electrically locking/unlocking outside lever, no cylinder <ul style="list-style-type: none"> Outside lever continuously locked (EL) or unlocked (EU) by 12V or 24V DC Auxiliary latch deadlocks latchbolt when door is closed Inside lever always free for immediate egress 	F13	L9091EL L9091EU Electrically locking/unlocking both levers, no cylinder* <ul style="list-style-type: none"> Both levers continuously locked (EL) or unlocked (EU) by 12V or 24V DC Auxiliary latch deadlocks latchbolt when door is closed 	—	L9092EL L9092EU Electrically locking/unlocking outside lever, outside cylinder <ul style="list-style-type: none"> Outside lever continuously locked (EL) or unlocked (EU) by 12V or 24V DC Latchbolt retracted by lever/knob inside or key outside Auxiliary latch deadlocks latchbolt when door is closed Inside lever always free for immediate egress EL: Switch or power failure allows outside lever to retract latchbolt EU: Switch or power failure locks (EU) outside lever 	—
Electrified		Electrified		Electrified	
Schlage L9093EL L9093EU Electrically locking/unlocking both levers, outside cylinder* <ul style="list-style-type: none"> Both levers continuously locked (EL) or unlocked (EU) by 12V or 24V DC Latchbolt retracted by key outside Auxiliary latch deadlocks latchbolt when door is locked 	—	Schlage L9094EL L9094EU Electrically locking/unlocking outside lever, inside and outside cylinder <ul style="list-style-type: none"> Outside lever continuously locked (EL) or unlocked (EU) by 12V or 24V DC Latchbolt retracted by either key or by inside lever Auxiliary latch deadlocks latchbolt when door is locked Inside lever always free for immediate egress 	—	Schlage L9095EL L9095EU Electrically locked or electrically unlocked both sides* <ul style="list-style-type: none"> Both knobs/levers continuously locked (EL) or unlocked (EU) by 12V or 24V DC Latchbolt retracted by either key Auxiliary latch deadlocks latchbolt when door is closed EL: Switch or power failure unlocks both knobs/levers and allows knob/lever to retract latchbolt EU: Switch or power failure locks both knobs/levers 	—
Electrified		Electrified		Electrified	

* **Caution:** Double cylinder locks on residences and any door in any structure which is used for egress are a life safety hazard in times of emergency and their use is not recommended. Installation should be in accordance with existing codes only.

L Series wired electrified lock functions

Schlage	ANSI	Schlage	ANSI	Schlage	ANSI
<p>L9492EL L9492EU</p> <p>Electrically locking/unlocking outside lever, outside cylinder, inside thumbturn, with deadbolt</p> <ul style="list-style-type: none"> • Outside lever continuously locked (EL) or unlocked (EU) 12V or 24V DC • Deadbolt actuation by key or thumbturn • Inside lever retracts both deadbolt and latchbolt • For EU outside lever retracts deadbolt and latchbolt • Auxiliary latch deadlocks latchbolt when door is closed • Inside lever always free for immediate egress 	—	<p>L9493EL L9493EU</p> <p>Electrically locking/unlocking both levers, outside cylinder, inside thumbturn, with deadbolt</p> <ul style="list-style-type: none"> • Deadbolt actuation by key or thumbturn • Inside lever retracts both deadbolt and latchbolt • For EU both levers retract deadbolt and latchbolt • Auxiliary latch deadlocks latchbolt when door is closed 	—	<p>L9494EL L9494EU</p> <p>Electrically locking/unlocking outside lever, inside and outside cylinders, with deadbolt</p> <ul style="list-style-type: none"> • Outside lever continuously locked (EL) or unlocked (EU) 12V or 24V DC • Deadbolt actuation by either key • Inside lever retracts both deadbolt and latchbolt • For EU outside lever retracts deadbolt and latchbolt • Auxiliary latch deadlocks latchbolt when door is closed • Inside lever always free for immediate egress 	—
Electrified		Electrified		Electrified	
<p>Schlage</p> <p>L9495EL L9495EU</p> <p>Electrically locking/unlocking both levers, inside and outside cylinders, with deadbolt*</p> <ul style="list-style-type: none"> • Both levers continuously locked (EL) or unlocked (EU) 12V or 24V DC • Deadbolt actuation by either key • When unlocked both levers retract deadbolt and opens door • Auxiliary latch deadlocks latchbolt when door is closed 	ANSI —				
Electrified					

* **Caution:** Double cylinder locks on residences and any door in any structure which is used for egress are a life safety hazard in times of emergency and their use is not recommended. Installation should be in accordance with existing codes only.

LE wireless electronic locks

The Schlage LE wireless mortise lock with ENGAGE™ technology is designed to affordably extend electronic access control deeper into the building beyond traditional perimeter and high security openings, offering enhanced security, efficiency, and the convenience of upgrading to electronic credentials. LE is ideal for office and suite entries, conference rooms, common area doors, resident units, and sensitive storage areas with a mortise door prep.

LE wireless locks simplify installation by combining the lock, credential reader, door position sensor and request-to-exit switch all in one unit. LE wireless locks require only minor modifications to existing mechanical mortise prep with no wires to run to the lock or additional hardware necessary.

Built-in Bluetooth® enables LE wireless locks to connect directly to smart phones and tablets; no need for a proprietary handheld device for set-up and configuration. And with built-in Wi-Fi®, LE locks can connect directly to an existing Wi-Fi network enabling automatic updates to lock configuration and user access. The ENGAGE cloud-based web and mobile apps make it easy to configure lock settings, add users, and view audits and alerts from anywhere.

For advanced capabilities including networked real-time communication with the ENGAGE Gateway, LE wireless locks can be managed with software from one of our Software Alliance Members.

Features

- Suites with mechanical L Series with 31 levers and 2 knobs, keyways and most finishes
- Weather-resistant design for use on perimeter doors
- Innovative integrated door position switch requires no additional door prep¹
- Up to 2 years of battery life

1. Door position switch requires additional prep for mortise deadbolt (MD) applications.



LE wireless electronic locks

Greenwich

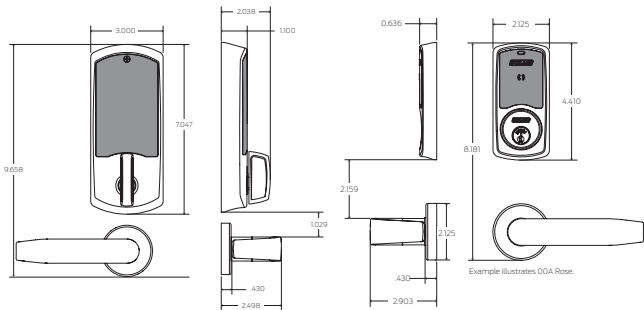

Addison

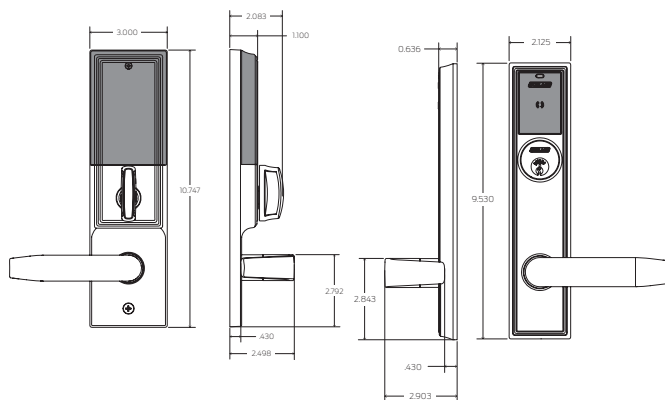

Available status signals

- Request to Exit
- Door position
- Interior cover tamper¹
- Battery status
- Lock/unlock status²
- Communication status¹
- Deadbolt position status (MD only)¹
- Interior pushbutton status (MB only)¹

Multi-technology reader specifications

Frequency	125 kHz proximity and 13.56 MHz smart credential
Standards	ISO standard 15693 and ISO 14443
Maximum read range	Up to 1.25" on 125 kHz proximity, up to 0.75" on 13.56 MHz smart credential

¹ Consult your access control software provider for specific scope of support.

² Software indicates lock/unlock status based on sequence of events.

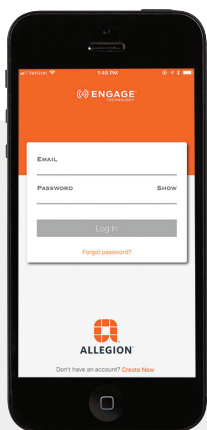

ENGAGE cloud-based web and mobile applications

ENGAGE cloud-based web and mobile apps make it easy to configure lock settings, manage access rights and view audits and alerts from anywhere.



LE wireless electronic lock functions

LEMS**LED Indicator****Storeroom**

- Lockset is normally secure
- Inside lever always free for immediate egress
- Valid toggle credentials on the exterior may be used to change to a passage or secured status
- A mechanical key will momentarily unlock the door

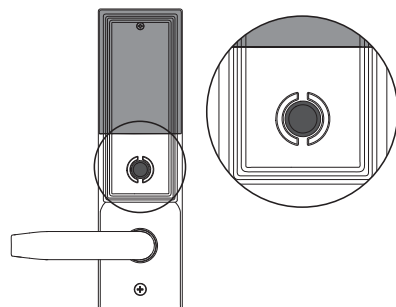
**LEMB****Interior Push Button and LED****Office**

- Lockset is normally secure
- Inside lever always free for immediate egress
- Interior pushbutton on inside housing may be used to select a privacy status
- Interior pushbutton will disable normal electronic access from the exterior
- Opening the door or pressing the interior pushbutton a second time on the inside housing deactivates the privacy status

Apartment

- Lockset is normally secure
- Inside lever always free for immediate egress
- Interior pushbutton on inside housing may be used to select a passage or secured status
- Opening the door or pressing the interior pushbutton causes the lockset to toggle unsecured
- While toggled unsecured, the lockset can only be secured while the door is closed by pressing the interior pushbutton or using a normal credential on the exterior
- Normal electronic access from the exterior is always allowed

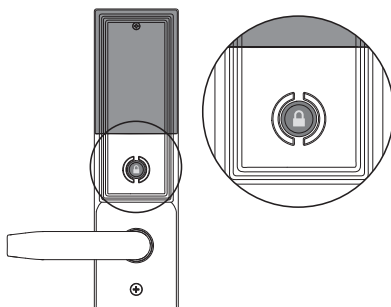
**LEMD****Deadbolt with LED****Privacy**

- Lockset is normally secure from exterior
- Inside lever always free for immediate egress and retracts both latchbolt and deadbolt
- The deadbolt may be used to select a privacy status
- With deadbolt extended, normal electronic access from the exterior will be disabled
- Opening the door or retracting deadbolt deactivates the privacy status

Apartment

- Lockset is normally secure from exterior
- Inside lever always free for immediate egress and retracts both latchbolt and deadbolt
- The deadbolt may be used to select a passage or secured status
- Opening the door or retracting the deadbolt causes the lockset to toggle unsecured
- While toggled unsecured, the lockset can only be secured while the door is closed by extending the deadbolt from inside or using a normal credential on the exterior reader
- Normal electronic access from the exterior is always allowed

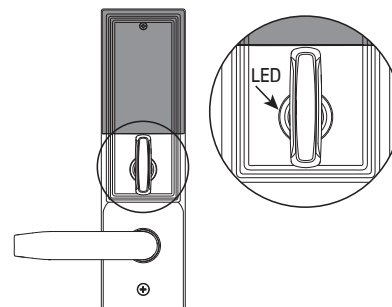

LM9200 multi-point locks

The Schlage LM9200 lock utilizes latches in the top and bottom of the door, rather than the side, on single or double sets of doors. Compatible with wood or hollow metal doors, the LM9200 is also available without the bottom latch for single point latching.

The LM9200 can easily integrate into any application and suite with other Schlage locks and Von Duprin exit devices.

Features

- Concealed vertical cables provide simple installation and reliable performance
- Compatible with sectional rose and escutcheon trim; does not require “backer plates” or metal wraps for fire protection
- Fire-rated for up to 60 minutes for wood door applications; 90 minute fire rating for hollow metal door applications
- 33 lever designs to suite with Schlage locks and Von Duprin exit devices
- Requires door designed specifically for two point latch system

Overview

Key features

Trims and finishes

Mechanical

Wired electrified

Wireless electronic

Multi-point







Key systems
and credentials

Parts

Ordering and
specifications







L Series LM9200 multi-point lock functions

Mechanical functions

Schlage	ANSI	Schlage	ANSI	Schlage	ANSI	Schlage	ANSI
LM9210	—	LM9225	—	LM9250	—	LM9256	—
Passage latch		Exit lock		Office/entry lock		Office/entry lock with auto unlock	
<ul style="list-style-type: none"> Both levers retract latchbolt at all times 		<ul style="list-style-type: none"> Inside lever retracts latchbolt No outside trim 		<ul style="list-style-type: none"> Both levers retract latchbolt unless outside is made inoperative by turning key or thumbturn When locked, key and outside lever or inside lever retracts latchbolt Inside lever always free for immediate egress 		<ul style="list-style-type: none"> Both levers retract latchbolt unless outside is made inoperative by turning key or thumbturn When locked, key and outside lever or inside lever retracts latchbolt Inside lever always free for immediate egress 	
							
LM9270	—	LM9271	F15	LM9280	—		
Classroom lock		Classroom security lock		Storeroom lock			
<ul style="list-style-type: none"> Both levers retract latchbolt unless outside is made inoperative by turning key When locked, key and outside lever or inside lever retracts latchbolt Inside lever always free for immediate egress 		<ul style="list-style-type: none"> Both levers retract latchbolt unless outside is made inoperative by turning either key When locked, key and outside lever or inside lever retracts latchbolt Inside lever always free for immediate egress 		<ul style="list-style-type: none"> Outside lever retracts latchbolt only after inserting key and rotating 280° Inside lever always free for immediate egress 			
							

L Series LM9200 multi-point lock functions

Electrified functions

Schlage	ANSI	Schlage	ANSI	Schlage	ANSI	Schlage	ANSI
LM9290EL LM9290EU	—	LM9291EL LM9291EU	—	LM9292EL LM9292EU	—	LM9293EL LM9293EU	—
Electrically locking/unlocking outside lever, no cylinder		Electrically locking/unlocking both levers, no cylinder		Electrically locking/unlocking outside lever, outside cylinder		Electrically locking/unlocking both levers, outside cylinder	
<ul style="list-style-type: none"> Outside lever continuously locked (EL) or unlocked (EU) electrically inside lever always free for immediate egress 		<ul style="list-style-type: none"> Both levers continuously locked (EL) or unlocked (EU) electrically 		<ul style="list-style-type: none"> Outside lever continuously locked (EL) or unlocked (EU) electrically Latchbolt retracted by outside key and lever, electrically unlocking door and outside lever, or anytime by inside lever Inside lever always free for immediate egress 		<ul style="list-style-type: none"> Both levers continuously locked (EL) or unlocked (EU) electrically Latchbolt retracted by outside key and lever, electrically unlocking door and outside lever 	
							
LM9294EL LM9294EU	—	LM9295EL LM9295EU	—				
Electrified outside levers lock two-point latch (inside and outside cylinder)		Electrically locking/unlocking both levers, Inside and outside cylinder					
<ul style="list-style-type: none"> Outside lever continuously locked (EL) or unlocked (EU) by 24V AC or DC Latchbolt retracted by outside key and lever, electrically unlocking door and outside lever, or anytime by inside lever 		<ul style="list-style-type: none"> Both levers continuously locked (EL) or unlocked (EU) electrically Latchbolt retracted by either key 					
							

Note: See page 33 for wiring instructions.

LM9300

multi-point locks

The LM9300 is part of a three-point locking system designed for tornado, hurricane or high security applications. Latches at the top, side and bottom of the door provide protection from high wind speeds and 15-lb. projectile impacts up to 100 mph when paired with a Steelcraft Paladin tornado-resistant door.



All three latches engage when the door is shut and retract simply by rotating the lever, providing superior protection with familiar operation. Available in six functions and with 33 lever designs, the LM9300 can easily integrate into any application and suite with other Schlage locks, as well as Von Duprin exit devices.

Features

- Tornado configuration complies with FEMA 361 and ICC500 tornado shelter guidelines when paired with Steelcraft Paladin doors
- Hurricane configuration complies with Florida Building Code Enhanced Protection Area (EHPA) standard when paired with Steelcraft Hurricane doors
- For high security applications, pair with Steelcraft steel-reinforced or honeycombed doors
- Vertical rods ship pre-aligned and pre-installed with Steelcraft doors, enabling quick and simple installation
- Also available for storm shutter configurations
- Compatible with all L Series trims, both sectional and escutcheon, and 33 lever designs

L Series LM9300 multi-point lock functions

Functions

<p>Schlage LM9310</p> <p>Passage latch</p> <ul style="list-style-type: none"> Both levers retract latchbolt Both levers always free for immediate egress Auxiliary latch deadlocks latchbolt when door is closed 	<p>ANSI —</p> <p>Schlage LM9325</p> <p>Exit lock</p> <ul style="list-style-type: none"> Inside lever retracts latchbolt No outside trim Auxiliary latch deadlocks latchbolt when door is closed 	<p>ANSI —</p> <p>Schlage LM9350 LMV9350</p> <p>Office and inner entry lock</p> <ul style="list-style-type: none"> Both levers retract latchbolt unless outside is made inoperative by turning key or thumbturn When locked, key and outside lever or inside lever retracts latchbolt Auxiliary latch deadlocks latchbolt when door is closed Inside lever always free for immediate egress 	<p>ANSI —</p>
<p>Schlage LM9370 LMV9370</p> <p>Classroom lock</p> <ul style="list-style-type: none"> Both levers retract latchbolt unless outside is made inoperative by turning key When locked, key and outside lever or inside lever retracts latchbolt Auxiliary latch deadlocks latchbolt when door is closed Inside lever always free for immediate egress 	<p>ANSI —</p> <p>Schlage LM9371 LMV9371</p> <p>Classroom security lock</p> <ul style="list-style-type: none"> Both levers retract latchbolt unless outside is made inoperative by turning either key When locked, key and outside lever or inside lever retracts latchbolt Auxiliary latch deadlocks latchbolt when door is closed Inside lever always free for immediate egress 	<p>ANSI —</p> <p>Schlage LM9380 LMV9380</p> <p>Storeroom lock</p> <ul style="list-style-type: none"> Outside lever retracts latchbolt only after inserting key and rotating 280° Auxiliary latch deadlocks latchbolt when door is closed Inside lever always free for immediate egress 	<p>ANSI —</p>

Readers, credentials and power supplies

Readers and credentials

Schlage's comprehensive portfolio of electronic credentials and wall mount readers are designed to provide enhanced levels of security, efficiency and convenience to any facility.

Proximity (125 kHz) technology:

- Basic open contactless technology; recommended for legacy systems only
- Encoded with a unique number that cannot be updated or changed

Smart (13.56 MHz) technology:

- Advanced contactless technology, more secure than magnetic stripe and proximity options
- Advanced data encryption secures against duplication
- Recommended for new systems
- Open platform, designed to work with a wide array of systems and applications beyond access control

Multi-technology options that provide flexibility:

- All multi-technology credentials and readers feature Schlage smart technology with either magnetic stripe or proximity
- Enables migration from legacy platform to secure smart technology
- Reader options available with keypad for high security applications



Credentials

Options include clamshell or ISO cards, keyfobs, wristbands and mobile.

Readers

Single-technology proximity (PR) and smart (SM) readers available in a mini mullion design. Multi-technology (MT) options include mullion, single gang and single gang with keypad (K).

Power supplies

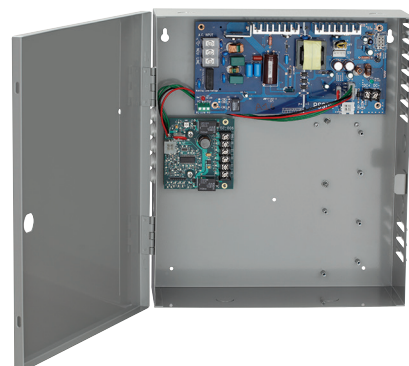

Schlage power supplies are designed for speed and ease of installation upfront with the assurance post installation of the highest quality output in terms of even power flow to protect downstream devices.

Cylinders and key systems

Cylinders and key systems

A strong lock is only part of the security solution—proper key control is equally important. Schlage offers extensive options to meet the security needs of the specific project.

Cylinders



Conventional mortise cylinder options¹

- 6-pin length (standard)
- 7-pin length in SL cylinder
- Available in Schlage Classic and Everest 29™ open and restricted keyways
- Primus® XP security features and geographic exclusivity
- Primus XP UL 437 listed high security features
- Faculty restroom function available



Full size interchangeable core (FSIC) options¹

- 6-pin length
- 7-pin length in SL cylinder
- Available in Schlage Classic and Everest 29 open and restricted keyways
- Interchangeable core compatible with conventional cylinder key systems
- Primus XP security features and geographic exclusivity



Small format interchangeable core (SFIC) options²

- 7-pin combined Everest 29 R restricted keyways³

¹ Available in 606, 622, 626 and 643 plug face finishes; Everest 29 S123 keyway standard.

² Available 606, 622, 626 and 643e finish only.

³ Restricted keyway cores require authorization from the end user.

Key systems

Classic keyway

- Open keyway—keys are duplicated and available without ordering formalities
- Upgradeable to Primus XP and UL 437 levels of security

Everest 29

- Patented through 2029
- Key duplication is restricted providing a higher level of security for the cylinder
- Can be integrated to an existing Everest B, C, or D system
- Upgradeable to Primus XP and UL 437 levels of security

Cylinder mechanism options

Primus XP





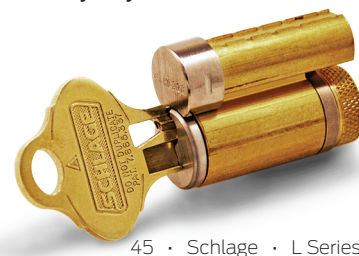

- Independent, dual locking mechanisms
- Unique side bit milling on key makes unauthorized duplication highly enforceable
- Allows creation of geographically exclusive keys in thousands of available combinations
- Provides patent protection when applied to Schlage Classic keyways
- Compatible to all Everest and Everest 29 keyways

Everest 29 SL

- Available in Conventional and FSIC cylinder formats
- Pinned on an A2 system compatible with the Schlage Everest B and Everest 29 R keyways
- Users can expand existing Everest B and Everest 29 R key systems
- Enables Primus XP upgrades on SFIC keyways

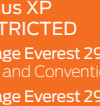
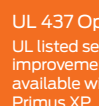

Cylinders and key systems

Administrative Security	Schlage Everest 29™					
	Schlage Classic	End user exclusive nationwide	4N		9N	
		End user exclusive within time zone/country	4Z		9Z	
	End user exclusive within zip code		3G		9G	
	End user controlled; non-exclusive		3U		9U	
	Dealer exclusive within time zone/country		2		8	
	Dealer exclusive within zip code		1+		7	
	Authorized dealer only; non-exclusive		1			
Mechanical	End user controlled; non-exclusive				Primus XP RESTRICTED	
	Authorized dealer only				Schlage Everest 29 R FSIC ² and Conventional ²	
	No authorization				Schlage Everest 29 S FSIC and Conventional	
	Schlage Classic FSIC and Conventional				Schlage Everest 29 T FSIC and Conventional	
Wired electrified	 <p>OPEN Schlage Classic FSIC and Conventional</p> <ul style="list-style-type: none"> Duplicate anywhere 		 <p>OPEN Schlage Everest 29 S FSIC and Conventional</p> <ul style="list-style-type: none"> Patented design Check pin in cylinder 		 <p>RESTRICTED Schlage Everest 29 R¹ FSIC, FSIC² and Conventional²</p> <p>Schlage Everest 29 T FSIC and Conventional</p> <ul style="list-style-type: none"> Requires letter of authorization Patented design Check pin in cylinder 	
			 <p>Primus XP RESTRICTED Schlage Classic FSIC and Conventional</p> <ul style="list-style-type: none"> 5 levels of side bit milling exclusivity Patent protection to 2024 Independent sidebar and finger pin locking mechanisms 		 <p>Primus XP RESTRICTED Schlage Everest 29 R FSIC² and Conventional²</p> <ul style="list-style-type: none"> 5 levels of side bit milling exclusivity Patent protection to 2029 Independent sidebar and finger pin locking mechanisms 	
					 <p>UL 437 Option UL listed security improvements available with Primus XP</p> <ul style="list-style-type: none"> Hardened steel drill pins Proven pick and drill resistant Withstands extreme physical attack 	
Physical Security						

COMPARABLE ELECTRONIC SECURITY - Ensure your credential is as secure as your keyway		
Proximity credentials <ul style="list-style-type: none"> Easily duplicated 	MIFARE Classic® smart credentials <ul style="list-style-type: none"> Secure encrypted data and communications Difficult to duplicate 	MIFARE Plus® and MIFARE® DESFire® EV1 smart credentials <ul style="list-style-type: none"> Advanced data encryption makes duplication nearly impossible Most secure credentials available from Schlage

1. Limited dealer controlled programs available.
 2. FSIC and Conventional in the form of SL cylinders that accept an SFIC key.

Primus XP access control and high security cylinders

Primus XP access control and high security cylinders are available to add patented key control and varying degrees of geographical exclusivity to most Schlage 6- and 7-pin key systems, whether Everest 29 or Classic keyways.

In addition to a standard pin tumbler mechanism, Primus cylinders incorporate a patented finger pin and sidebar design, providing a “dual-locking” cylinder that is virtually pick-proof. Resistance to drilling and other physical attack is optional by specifying 20-500 Series UL 437 Listed high security cylinders.

Classic Primus XP cylinders are recommended for upgrading existing Classic key systems. Due to its extended patent life, Everest 29 Primus XP is recommended for new key systems and for upgrading existing Everest key systems. Specify keyway to differentiate between Everest 29 and Classic. Example: C or CP (Classic) vs. S123 (Everest 29).

Conventional cylinders

Mortise cylinders for Schlage L Series

L and N
Escutcheons

Cylinder only

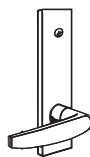

L escutcheon

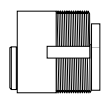
Concealed
body cylinder

Sectional trim

Compression
ring and spring

L Series mortise locksets

Design	Function	Standard pin and tumbler	SL cylinder ¹	Primus/ Primus XP	Primus XP SL cylinder ¹	Primus UL 437/ Primus XP UL 437	Primus XP lockout	Primus XP UL 437 lockout
L and N Escutcheons (cylinder and compression spring only)	All except below	30-021	91-063	20-793/ 20-793-XP	91-760-XP	20-593/ 20-593-XP	20-717 ³	20-517 ³
	L9060P outside	26-021	91-059	20-701/ 20-701-XP	91-754-XP	20-501/ 20-501-XP	20-715 ³	20-515 ³
	L9485, L9486 faculty restroom	30-022 ²	N/A	N/A	N/A	N/A	N/A	N/A
	LM9280 storeroom	30-000 ²	N/A	N/A	N/A	N/A	N/A	N/A
L escutcheon with concealed body cylinder (C suffix)	All except below	30-004	N/A	20-789/ 20-789-XP	N/A	20-589/ 20-589-XP	N/A	N/A
	L9060P outside	26-023	N/A	24-767/ 24-767-XP	N/A	24-567/ 24-567-XP	N/A	N/A
	L9485, L9486 faculty restroom	30-005 ²	N/A	N/A	N/A	N/A	N/A	N/A
Sectional trim (cylinder with compression ring and spring)	All except below	30-001	91-062	20-787/ 20-787-XP	91-757-XP	20-587/ 20-587-XP	20-715	20-517
	L9060P outside	20-001	91-051	20-700/ 20-700-XP	91-751-XP	20-500/ 20-500-XP	20-715	20-515
	L9485, L9486 hotel functions	30-002 ²	N/A	N/A	N/A	N/A	N/A	N/A

¹ For restricted Everest 29 R and Everest B only

² Specify door hand for faculty restroom and multi-point storeroom cylinders

³ Discard compression ring for Lockout cylinders with escutcheon trim

Finishes: 605, 606, 611, 612, 613, 619, 622, 625, 626, 629 and 630.

Concealed cylinders available in 606, 622, 626 and 643e only.

Plug faces available in 606, 622, 626 and 643e only.

6-pin Everest 29 S123 keyway standard for stock cylinders; S145 standard for new key systems.

Standard cylinder lengths: sectionals (rose) trim = 1¹/₈" (29 mm), escutcheon trim = 1¹/₄" (32 mm).

Optional cylinder lengths are in 1¹/₈" (4 mm) increments ranging from 1¹/₈" to 1³/₄" (29 mm to 44 mm).

Full size interchangeable cores

FSIC mortise cylinders

Schlage figure-8 interchangeable core (IC) cylinders allow immediate rekeying at the door. Simply use the special control key to replace the core in seconds. Full-size IC cylinders can be integrated into any existing 5- or 6-pin Schlage key system with no adverse effects on keying capacity. Convert existing mortise locks to interchangeable core merely by replacing the old cylinder with the IC cylinder and proper collar(s).

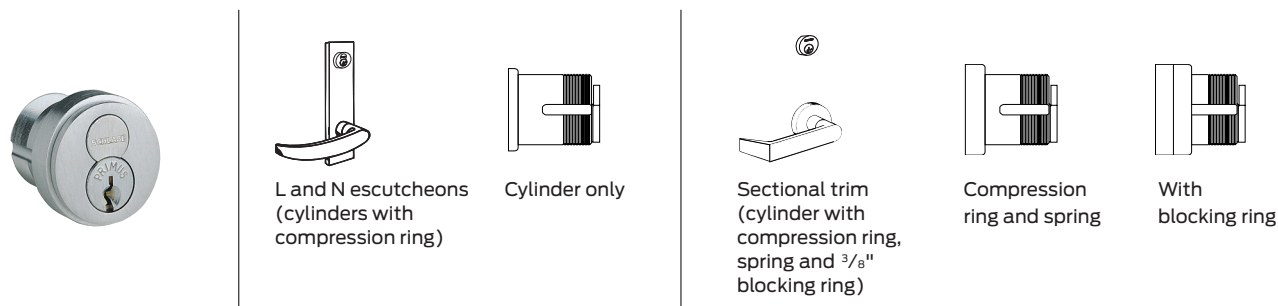

FSIC cylinders for Schlage L Series mortise locks

Design	Function	Core mechanism				
		Standard pin and tumbler	SL cylinder ¹	Primus Primus XP	Primus XP SL cylinder ¹	Housing less core
L and N escutcheons (cylinders with compression ring)	All except below	30-008	91-163	20-798 20-798-XP	91-863-XP	30-007
	L9060 outside	30-030	91-165	20-782 20-782-XP	91-865-XP	30-032 + 36-083
	L9485, L9486 faculty restroom	30-010 ²	N/A	N/A	N/A	N/A
Sectional trim (cylinder with compression ring, spring and 3/8" blocking ring). 9060 requires 1/2" blocking ring.	All except below	30-138	91-169	20-776 20-776-XP	91-869-XP	30-137
	L9060 outside	30-030 + 36-082-050	91-165 + 36-082-050	20-783 20-783-XP	91-865-XP + 36-082-050	30-032 + 36-083 + 36-082-050
	L9485, L9486 faculty restroom	30-140 ²	N/A	N/A	N/A	N/A

¹ For restricted Everest 29 R and Everest B only.

² Faculty restroom function cores are handed. Specify hand of door.

Finishes: 605, 606, 609, 612, 613, 619, 622, 625, 626, and 643e.

Standard cylinder length is 1 1/2".

FSIC, core only, cylinders

Number	Pins	Cylinder mechanism
23-030	6	Standard pin and tumbler
23-031	6	Standard pin and tumbler, less logo
91-161	7	SL cylinder (restricted Everest 29 R and Everest B only)
91-162	7	SL cylinder, less logo (restricted Everest 29 R and Everest B only)
20-740	6	Primus
20-741	6	Primus, less logo
20-740-XP	6	Primus XP
20-741-XP	6	Primus XP, less logo
91-861-XP	7	SL cylinder (restricted Everest 29 R and Everest B only)
91-862-XP	7	SL cylinder, less logo (restricted Everest 29 R and Everest B only)
30-120	6	Faculty restroom standard pin and tumbler (specify hand)
30-121	6	Faculty restroom standard pin and tumbler, less logo (specify hand)

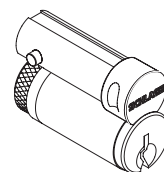

Finishes: 606, 622, 626 and 643e only.

Standard keyway: 6-pin Everest 29 S123 for stock, S145 for new master key systems.

Small format interchangeable cores

SFIC mortise cylinders

The L Series lockset can be ordered to accept small format interchangeable cores (SFIC) compatible with manufacturers such as Falcon, Arrow and Best; cams are easily changeable.

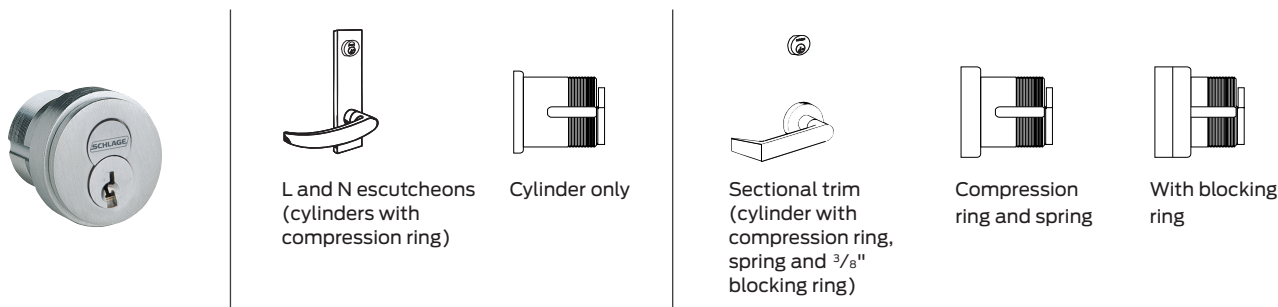

SFIC cylinders for Schlage L Series mortise locks

Design	Function	Core mechanism			
		Everest 29 restricted (GD suffix)	Keyed construction (HD suffix)	Disposable construction (BDC suffix)	Housing less core (BD suffix)
L and N escutcheons (cylinders with compression ring and spring)	All except L9060 outside	80-308	80-138	80-115	80-108
	L9060 outside	80-304	80-134	80-112	80-104
Sectional trim (cylinder with compression ring, spring and 1/4" blocking ring).	All except L9060 outside	80-301	80-131	80-109	80-101
	L9060 outside	80-304 + 36-082-050	80-134 36-082-050	80-112 36-082-050	80-104 36-082-050

Notes

- Available in 605, 606, 609, 612, 613, 619, 625, and 626 finish. Cores furnished 606 and 626 only.
- All cylinders are 1 3/8" long.

Small format core only

Number	Mechanism
80-036	7-pin Everest 29 R family restricted keyway core uncombined
80-037	7-pin Everest 29 R family restricted keyway core combined
80-043	6-pin best keyway core, uncombined
80-033	7-pin best keyway core, uncombined

Notes

- Available in 606, 613 and 626 finish only. 80-043 and 80-033 available in 606 and 626 only.
- Suffix keyway, e.g. 80-036 B235, 80-043 AB, etc.
- Proper authorization required for Everest 29 cores. Order control keys separately.
- 80-043 and 80-033 available in Best A, D, E, F, G, H, J, K, L and M keyways. Suffix "B" to keyway letter, e.g. AB, DB, etc.

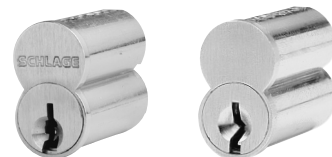

Parts and options

Blocking and compression rings

36-079



Blocking ring.
Specify finish
and dimension.
Not to be used
with 36-083.

36-082



Blocking ring.
Specify finish
and dimension.
Use with 36-083.

36-083

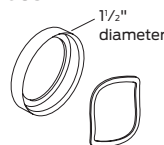

Compression ring
and spring. Specify
finish and dimension.

L538-195



Compression
spring.

Blocking ring dimensions

Ring length	Dimension
1/8"	012
3/16"	018
1/4"	025
5/16"	031
3/8"	037
7/16"	043
1/2"	050

FSIC core blocking ring requirements

Function	Trim	Door thickness			
		1 3/8"	1 3/4"	2"	2 1/4"
Dimension					
L9050, L9056, L9070, L9076, L9080, L9092EL/EU, L9453, L9456, L9460 per XL11-886 or XL11-635, L9464 per XL11-886, L9465, L9473, L9480	Rose	050	037	025	025
	Escutcheon	025	012	N/R	N/R
L9485 per XL11-557	Rose	—	037	025	025
	Escutcheon	—	012	N/R	N/R
L9486, L9496	Rose	012	N/R	N/R	N/R
	Escutcheon	025	012	N/R	N/R
L9060, L9071, L9077, L9082, L9457, L9462 per XL11-886, L9466, L9482	Rose	—	050	043	031
	Escutcheon	025	012	N/R	N/R
L460, L464, L496, L9460, L9464	Rose trim	050	037	025	025
L462, L463, L9462, L9463	Rose trim	—	050	043	031

SFIC blocking ring requirements

Function	Trim	Door thickness			
		1 3/8"	1 3/4"	2"	2 1/4"
Dimension					
L9050, L9056, L9070, L9076, L9080, L9092EL/EU, L9453, L9456, L9460 per XL11-886 or XL11-635, L9464 per XL11-886, L9465, L9473, L9480	Rose	037	025	012	N/R
	Escutcheon	N/R	N/R	N/R	N/R
L9060, L9071, L9077, L9082, L9095EL/EU, L9457, L9462 per XL11-886, L9464, L9466, L9482	Rose	—	050	037	025
	Escutcheon	018	N/R	N/R	N/R
L9496	Rose	025	012	N/R	N/R
	Escutcheon	N/R	N/R	N/R	N/R
L460, L464, L496, L9460, L9464	Rose trim	037	025	012	N/R
L462, L463, L9462, L9463	Rose trim	—	050	037	025

Parts and options

These cylinders are for L463 and L9463 classroom function deadlocks. They are handed. They have a rotational stop in one direction to prevent locking from the inside, but allow unlocking. Cylinders are field-reversible by changing the position of the rotational stop. All cylinders furnished with L583-254 cam.

Classroom thumbturn cylinders	
Number	Collar(s)
09-900	None
09-904	Compression ring and spring
09-905	For 1 ³ / ₄ " doors: compression ring, spring and 1/8" blocking ring
09-907	For 1 ³ / ₄ " doors: compression ring, spring and 1/8" blocking ring

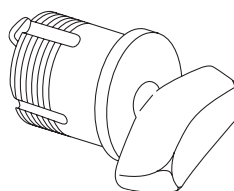

Specify hand of door and finish. 1¹/₈" length standard.
09-900 and 09-905 also available in 1/8" increments up to 1³/₄".

Mortise cylinder cams

	Most functions L9000 and L400 Series			L9060 outside only		
Current cams						
	L583-474 For cylinder lengths: 1 ¹ / ₈ ", 1 ³ / ₈ ", 1 ⁵ / ₈ "	L583-800 For SL cylinder length: 1 ¹ / ₈ "	L583-255 All IC	L583-476 For cylinder lengths: 1 ¹ / ₈ ", 1 ³ / ₈ ", 1 ⁵ / ₈ "	L583-802 For cylinder length: 1 ¹ / ₈ "	K510-680 All IC
	L583-475 For cylinder lengths: 1 ¹ / ₄ ", 1 ¹ / ₂ ", 1 ³ / ₄ "	L583-801 For SL cylinder length: 1 ¹ / ₄ "		L583-477 For cylinder lengths: 1 ¹ / ₄ ", 1 ¹ / ₂ ", 1 ³ / ₄ "	L583-803 For cylinder length: 1 ¹ / ₄ "	
Legacy cams						
	L583-153 Everest 29 and Primus XP*	L583-254 Classic conventional*		B502-948 Everest 29 and Primus XP*	B502-191 Classic conventional*	

* For cylinders made prior to July 2010

Cam screws	
B502-942	Everest and Primus (non-IC)
B502-468	Classic Conventional (non-IC)
L583-333	All full-size interchangeable core
B520-484	All small format interchangeable core
B520-690	All 1 ¹ / ₈ " and 1 ¹ / ₄ " modular cylinders



IC installation tool

This tool is used to install and remove mortise cylinder housings and test mortise cylinder cam action for both small format and full-size interchangeable core cylinders. Its other ends are designed to install the driver and retainer for full-size IC in Schlage key-in-knob/lever locksets.

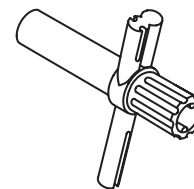

M504-413

Parts and options

L Series armored fronts are produced from brass, bronze or stainless steel material, finished to match lock trim and furnished complete with screws. Numbers for ordering separately or with locks are listed below. Armored fronts are specified in latch column of order form.

Armored fronts

Square corner		Description
1 ¹ / ₄ " (32mm) width	1 ¹ / ₁₆ " (27mm) width	
09-662	09-668	Latch: L9010, 9040, 9044
09-663	09-669	Deadlatch: L9050, 9056, 9060, 9070, 9071, 9080, 9082
09-664	09-670	Latch x deadbolt: L9444, 9456, 9457, 9465, 9466, 9473, 9496
09-665	09-671	Deadbolt: L9460, 9462, 9463, 9464
09-666	09-662	Deadlatch x deadbolt: L9453, 9480, 9485, 9486
09-661	09-667	Blank (no holes): L9175, L917
09-713	–	Deadlatch, non-UL: L9076, 9077 (holdback functions)
09-717	–	Deadbolt: L400 Series

Note: For 1³/₈" (35mm) doors, 1¹/₁₆" (27mm) front should be specified. See price book for complete list.

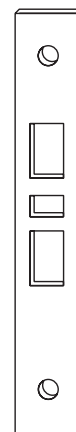

Standard square corner
1¹/₄" (32 mm) width

All L Series strikes are produced from brass, bronze or stainless steel material, finished to match lock trim, and furnished complete with screws. Numbers for ordering separately or with locks are listed below.



Standard for L9000
10-072
1¹/₄" x 4⁷/₈" x 1³/₁₆" lip
32 mm x 124 mm x 30 mm

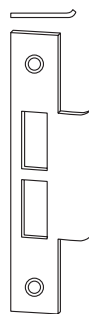

Armored front strike
10-091
1³/₄" x 8" x 1³/₁₆" lip
32 mm x 203 mm x 30 mm



Wood frame reinforcer
37-015



Standard for L400
10-079
1¹/₈" x 3¹/₂"
32 mm x 89 mm



Optional for L400
10-078
1¹/₄" x 4⁷/₈"
32 mm x 124 mm

Strikes

Number	Lip length	Description
10-072	1 ³ / ₁₆ " (30mm)	L9000 standard
	7 ⁷ / ₈ " (22mm), 1" (25mm), 1 ¹ / ₂ " (38mm)	L9000 optional
	1 ³ / ₄ " (44mm), 2" (51mm)	L9000 special lip
10-073	No lip	L9460 Series deadlocks
10-075	No lip	1 ¹ / ₂ " (13mm) rabbeted (use with 1 ¹ / ₁₆ " (27mm) armor)
10-078	No lip	1 ¹ / ₄ " x 4 ⁷ / ₈ " with box, L400 optional
10-079	No lip	1 ¹ / ₈ " x 3 ¹ / ₂ " with box, L400 standard
10-091*	1 ³ / ₁₆ " (30mm)	Armored front strike, no box
K510-053	–	Strike box for 10-079
K10-066	–	Strike box, all except 10-079

*Specify hand of inactive leaf.

Door handing

One of the revolutionary features of the L Series mortise lock is that handing can be done by the distributor or installer quickly and easily without opening the lock case. This feature allows a Schlage distributor to order L Series locks as stock and customize the handing to each order's specification. This means off-the-shelf delivery to meet today's fast-track construction requirements. These mix-and-match lever-with-knob combinations, along with a quickly reversible lock chassis, provide the ultimate in stocking, ordering and installation flexibility. Orders can be filled from stock, minimizing delivery problems.

Changing lock hand

No more than two simple steps are required to change the hand of any L Series lock. Rotate the latch unit 180° and/or change the catch screw position.

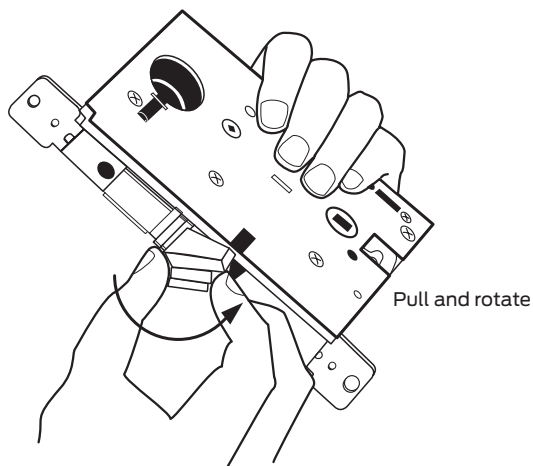

A. Changing latchbolt handing

Remove armored front. Pull latchbolt away from chassis and rotate complete unit 180° to reverse the door handing. Reinstall armored front.

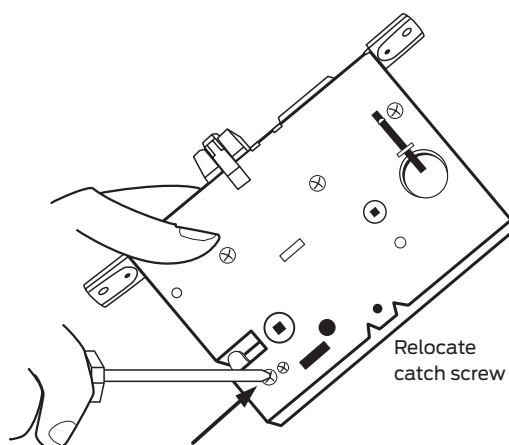

B. Change chassis handing

Remove catch screw from one side of chassis and install on opposite side. For RH and RR, the catch screw will be on the lock case side. For LH and LR, the catch screw will be on the lock case cover.

Note: Catch screw location reversed for Vandlgard function.

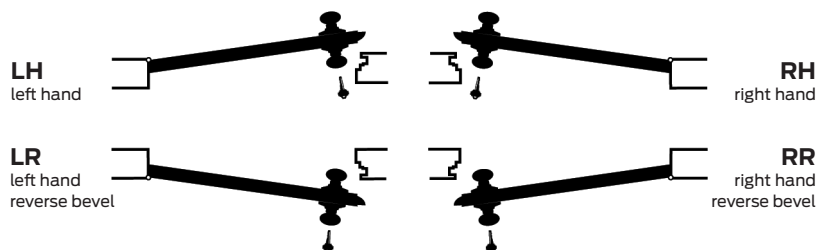

The hand is determined by the direction the door swings when viewed from the exterior or corridor side of the door.

How to order

L Series ordering instructions

To order Schlage products, descriptive data should be in the same sequence as shown:

Line item	Qty	Product	Outside		Inside		Hand	Front	Strike	Door thickness	Ext	Dim	Additional details
			Des	Fin	Des	Fin							
1	2	3	4	5	6	7	8	9	10	11	12	13	14

Detail

1 Line item number

2 Quantity

3 Complete model number with function and cylinder type
(Example: L9453P) (P cylinder is standard)

See catalog page 22 or price book for other mortise cylinder, SFIC, FSIC and Less Cylinder options.

4/5 Outside design/finish

Specify tactile warning (knurling) here as "8" before lever design, e.g. 803. To specify complete design, combine the numeric knob or lever design with the alpha rose or escutcheon design. Example: 03L, 93A, 42B. When ordering Mediterranean design levers with L escutcheons, specify AST/00L, AVA/00L or MER/00L.

6/7 Inside design/finish - leave blank if same as outside

8 Hand - one hand per line item

For standard 1 3/4" door thickness lines 9-13 are standard and do not need to be defined

9 Front (use "Strike" field on Schlage form) - leave blank for standard armored front or enter number for narrow front

10 Strike - leave blank for standard or specify part number for optional strike (LLL = Less strike)

100 = 1" 114 = 1 1/4" 112 = 1 1/2" 200 = 2"
118 = 1 1/8" 138 = 1 3/8" 134 = 1 3/4"

11 Door thickness - if non-standard (Example: 200 = 2")

12 Extension - to specify whether thick door is extended inside (EI), outside (EO), differently (ED) or equally (EE)

13 Dimension for strike lip lengths - see strike page for availability of specific dimensions with specific strikes

14 Additional details such as:

- Keying detail (e.g. key symbol, keyway, bitting)
- Wired Electrified options (e.g. RX, LX, DPS, DM)
- Other special requirements

Example

Line item	Qty	Product	Outside		Inside		Hand	Front	Strike	Door thickness	Ext	Dim	Additional details
			Des	Fin	Des	Fin							
1	50	L9453P	03A	626			RH		10-091				
2	10	L9040	03A	626	625		LH	09-668		138			
3	50	L9456P	07L	626	625		RH	09-668					

How to order

LE wireless electronic lock ordering instructions

LE - MS - GRW - P - 07 - 626 - 00A - 17 - 612 - 00A - LH - 10-136 - 134 - S123

Series	Chassis/ function	Style	Cylinder type	Outside			Inside (optional)			Handing	Strike lip	Door thickness	Key system	Additional options
				Lever style	Finish	Rose (GRW only)	Lever style	Finish	Rose (GRW only)					
1	2	3	4	5	6	7	8	9	10	11	12	13	14	15

Selections correspond with the numbers above

Standards options are indicated in bold. See price book for specific configuration options.

Detail

1	Series	LEMS	Mortise with indicator only
2	Chassis	LEMB	Mortise with interior push button
3	Function	LEMD	Mortise with deadbolt
See page 38 for descriptions of functions available.			
3	Style	GRW	Greenwich (sectional)
		ADD	Addison (escutcheon)
4	Cylinder	P	Mortise cylinder, 5- or 6-pin
See price book for other mortise cylinder, SFIC, FSIC and Less Cylinder options.			
5/8	Lever style	Available in 31 levers and two knob styles.	
See pages 12-15 for more information.			
6/9	Finish	605	Bright brass (US3)
		606	Satin brass (US4)
		612	Satin bronze (US10)
		619	Satin nickel (US15)
		622	Matte black (US19)
		625	Bright chrome (US26)
		626	Satin chrome (US26D)
		626AM	Satin chrome anti-microbial
		643e	Aged bronze (US11)
7/10	Rose (GRW style only)	00A	2 1/8" (54 mm) diameter
		00B	2 9/16" (65 mm) diameter
		00C	2 5/8" (66 mm) diameter with bevel (not available in 612 finish)
MER and AVA decorative rose options are also available, but only with MER and ACC lever styles. Inside rose will default to outside unless specified.			
11	Handing	RH	Right hand
		LH	Left hand
		RHR	Right hand reverse
		LHR	Left hand reverse
Defaulted to Right Hand, if not specified. The chassis can be changed in the field, with some exceptions. See pricebook for additional details.			
12	Strike plate/lip length	10-136	1 3/16" lip length (MS and MB)
		10-072	1 3/16" lip length (MD)
Additional lip length options 7/8" to 1 3/4". See price book for details.			
13	Door thickness	134	1 3/4" (44 mm)
Optional: 1 3/4" (44 mm) to 2 1/4" (57 mm), 2" maximum door thickness on SFIC cylinders. See price book for additional details.			
14	Keying type	S123	Everest 29
See price book for other available keyway options including master keying.			
15	Additional options		

Mechanical product specifications

	L mechanical and L wired electrified	LM9200	LM9300
Chassis			
Case material	CRS with zinc dichromate plating		
Case size	L9000 Series: 4 7/16" x 6 1/16" x 1" (113 mm x 154 mm x 25 mm) L400 Series: 4 7/16" x 3 5/8" x 1" (113 mm x 92 mm x 25 mm)	4 7/16" x 12 19/32" X 1" (113 mm x 320 mm x 25 mm)	4 7/16" x 6 1/16" x 1" (113 mm x 154 mm x 25 mm) (chassis only)
Spacing	Knob or lever to cylinder: 3 7/8" (98 mm); knob or lever to thumbturn hub: 2 11/16" (68 mm)		
Door thickness	Standard: 1 3/4" (44 mm) Optional: 1 3/8" (35 mm) to 2 1/2" (64 mm) Over 2 1/2" (64 mm) door ranges vary by function. Specify door thickness if other than 1 3/4" and position in door EE, EI, EO, ED	Standard: 1 3/4" (44 mm) Optional: 1 3/8" (35 mm) to 2 1/2" (64 mm) Over 2 1/2" (64 mm) door ranges vary by function. Specify door thickness if other than 1 3/4" and position in door EE, EI, EO, ED	Standard: 1 3/4" (44 mm)
Handing	L9000 Series: Field-reversible without disassembly L400 Series: Non-handed	Handed to order, field reversible	Handed to order, not field reversible
Trim			
Levers/knobs	33 lever designs (see page 12-15): Forged brass or bronze and cast stainless steel Two knob designs (see page 15): Heavy-duty wrought brass, bronze or stainless steel Ligature resistant lever (SL1) and knob (SK1) HL6 hospital latch (available on 9010 and 9040 functions only) Tactile warning applied to outside lever; available on 01, 02, 03, 05, 06, 07, 12, 17, 18, M51, M52, M81, ME1, ME2, ME3 lever designs		
Roses/escutcheons	L escutcheons: 7 15/16" x 1 3/4" x 7/16" (202 mm x 44 mm x 11 mm); cold-forged brass or bronze and stainless steel N escutcheons: 7 7/8" x 2 1/2" x 7/16" (200 mm x 64 mm x 11 mm); heavy wrought reinforced brass, bronze and stainless steel Roses: A, B, C: wrought brass or bronze and stainless steel; AVA and MER: forged brass		
Finishes	14 available: 605, 606, 609, 612, 613, 619, 622, 625, 626, 626AM, 629, 630, 630AM, 643e		
Combinations	Available with knob both sides, lever both sides, or knob/lever combinations. Roses cannot be combined with escutcheons.		
Latches			
Backset	2 3/4" (70 mm) only		
Armor	L9000 Series Standard: 1 1/4" x 8" x 7/32" (32 mm x 203 mm x 6 mm) Optional: 1 1/16" x 8" x 7/32" (27 mm x 203 mm x 6 mm) L400 Series: 1 1/4" x 5 9/16" x 7/32" (32 mm x 141 mm x 6 mm)	1 1/4" x 15 55/64" x 7/32" (32 mm x 403 mm x 6 mm)	Standard: 1 1/4" x 8" x 7/32" (32 mm x 203 mm x 6 mm) Optional: 1 1/16" x 8" x 7/32" (27 mm x 203 mm x 6 mm)
Bolt	1" (25 mm) throw stainless steel deadbolt 3/4" (19 mm) throw stainless steel latch with anti-friction tongue	Via concealed vertical cable	3/4" (19 mm) throw stainless steel latch
Strike	L9000 Series Standard: ANSI curved lip strike 1 1/4" x 4 7/8" (32 mm x 124 mm) x 1 3/16" (30 mm) lip to center with dust box Optional: Extended lip strike options (7/8", 1", 1 1/2", 1 3/4", 2") L400 Series Standard: 1 1/8" x 3 1/2" (29 mm x 89 mm) with dust box Optional: 1 1/4" x 4 7/8" (32 mm x 124 mm) with dust box	Via concealed vertical cable	Standard: ANSI curved lip strike 1 1/4" x 4 7/8" (32 mm x 124 mm) x 1 3/16" (30 mm) lip to center with dust box Optional: Extended lip strike options (7/8", 1", 1 1/2", 1 3/4", 2")

Mechanical product specifications (cont.)

	L mechanical and L wired electrified	LM9200	LM9300
Cylinders and key systems			
Formats	Standard: Pin and tumbler mechanism in the Patented Schlage Everest 29 S123 keyway (6-pin); two nickel silver cut keys per lock Additional keying options available: Conventional and interchangeable cores; master and grand master keying; compatible with competitor cylinders and cams that support the L9000 Series		
Wired electrified			
Input voltage	12V or 24V DC for L909X	12V or 24V DC for LM92X	—
Operating mode	Fail Safe or Fail Secure via switch on chassis	Fail Safe or Fail Secure via switch on chassis	—
Current draw	0.23 amps maximum; 0.01 amps holding	0.23 amps maximum; 0.01 amps holding	—
Request to Exit	Modular option on L909X and L949X electrified functions (when ordering or added in field) Available upon request: L9010/50/56/70/71/80 and L9453/56/58/65/66/80/85 mechanical functions Rating: 3A @ 125V AC/2A @ 30V DC	—	—
Latch bolt monitor	Available on all L909x and L949x electrified and L9010/25/26/50/56/70/71/80/82 and L9453/56/65/66/80/85 mechanical functions	—	—
Door position sensor	Internal available on L909x electrified and L9010/80/82 mechanical functions; external available on all functions	—	—
Deadbolt monitor	Available on L949x electrified and L9453/56/57/58/80/85/86/96 mechanical functions	—	—
Warranty			
	3 year limited mechanical and 1 year limited electromechanical	3 year limited mechanical and 1 year limited electromechanical	3 year limited mechanical
Certifications			
ANSI/BHMA	L/LV9000: ANSI/BHMA A156.13-2017 Series 1000, Grade 1 Operational and Security With FSIC interchangeable core cylinders: Grade 2 Security With SFIC interchangeable core cylinders: Grade 3 Security ASTM F476-76 Grade 40 L400: ANSI/BHMA A156.36 Grade 1	ANSI/BHMA A156.37-2014 Grade 1 Operational and Security With FSIC interchangeable core cylinders: Grade 2 Security With SFIC interchangeable core cylinders: Grade 3 Security	ANSI/BHMA A156.37-2014 Grade 1 Operational and Security With FSIC interchangeable core cylinders: Grade 2 Security With SFIC interchangeable core cylinders: Grade 3 Security
ICC	Complies with ICC A117.1 Accessible and Usable Buildings and Facilities	—	—

Mechanical product specifications (cont.)

	L mechanical and L wired electrified	LM9200	LM9300
UL/cUL	<p>UL 10C and CAN/ULC-S104 3-hour Fire Listed</p> <p>All locks listed for A label single doors, 4' x 10' and pairs 8' x 10'</p> <p>Letter F and UL symbol on latch front indicate listing</p> <p>Electrified functions are UL/ULC Listed for single-point locking applications</p> <p>UL 437 Listed when using UL 437 cylinder</p> <p>UL Listed for 3-hour fire door (except L9076 and L9077)</p>	<p>UL 10C and CAN/ULC-S104 1 1/2 hour maximum Fire Listing - pairs only</p> <p>UL 437 Listed when using UL 437 cylinder</p> <p>Hollow metal: Pair swinging same direction 2 point or LBL, 8' x 8': 90 minute; pair double egress w/astragal 2 point or LBL, 8' x 8': 90 minute</p> <p>Wood covered: Composite core pair swinging same direction 2 point, 8' x 8': 45 minute; composite core pair swinging same direction LBL, 8' x 8': 20 minute no hose stream</p>	<p>UL 10C and CAN/ULC-S104 3-hour Fire Listed</p> <p>UL 437 Listed when using UL 437 cylinder</p> <p>When furnished with the door trim and strike plate, is intended for use on single swing doors or on the active leaf of door pairs rated up to and including 3 hour, with individual door leaves measuring up to and including 4' x 8'</p>
CA Fire Code	All levers with a return to door of 1/2" (64 mm) or less comply (Formerly Title 19, California State Fire Marshal Standard)		
FL Building Code	Miami-Dade NOA's and Florida Building Commission Listings	—	Florida Building Commission Listings
Tornado	—	—	<p>Tornado Assembly Approvals: With Intertek Testing</p> <p>UL approved to FEMA 361 and FEMA 320 and ICC 500 tornado shelter guidelines when paired with Steelcraft Paladin doors and frames</p>

Wireless electronic product specifications

LE wireless electronic	
Chassis	
Case material	CRS with zinc dichromate plating
Case size	4 7/16" x 6 1/16" x 1" (113 mm x 154 mm x 25 mm)
Spacing	Knob or lever to cylinder, 3 7/8" (98 mm); knob or lever to thumbturn hub, 2 11/16" (68 mm)
Door thickness	<p>Standard: 1 3/4" (44 mm)</p> <p>Optional: Up to 2 1/4" (57 mm)</p> <p>SFIC limited to 2" max</p>
Handing	Handed to order, field reversible
Trim	
Levers/knobs	<p>31 lever designs (see page 12-15): Forged brass or bronze</p> <p>Two knob designs (see page 15): Heavy-duty wrought brass or bronze</p> <p>Tactile warning applied to outside lever; available on 01, 02, 03, 05, 06, 07, 12, 17, 18, M51, M52, M81, ME1, ME2, ME3 lever designs</p>
Roses/escutcheons	<p>Addison escutcheon</p> <p>Greenwich sectional with rose: A ,B ,C, AVA, MER</p> <p>Roses: A ,B ,C can be wrought brass or bronze and stainless steel; AVA and MER are forged brass</p>
Finishes	Nine available: 605, 606, 612, 619, 622, 625, 626, 626AM, 643e

Wireless electronic product specifications (cont.)

LE wireless electronic

Latches	
Backset	2 ³ / ₄ " (70 mm) only
Armor	1 ¹ / ₄ " x 8" x ⁷ / ₃₂ " (32 mm x 203 mm x 6 mm)
Bolt	1" (25 mm) throw stainless steel deadbolt ³ / ₄ " (19 mm) throw stainless steel latch with anti-friction tongue
Strike	Standard: ANSI curved lip strike 1 ¹ / ₄ " x 4 ⁷ / ₈ " (32 mm x 124 mm) x 1 ³ / ₁₆ " (30 mm) lip to center with dust box Optional: Extended lip strike options (1 ¹ / ₂ ", 1 ³ / ₄ ")
Cylinders and key systems	
Formats	Standard: Pin and tumbler mechanism in the Patented Schlage Everest 29 S123 keyway (6-pin); two nickel silver cut keys per lock Additional keying options available: Conventional and interchangeable cores; master and grand master keying; compatible with competitor cylinders and cams that support the L9000 Series
Wireless electronic	
Input voltage	4 AA batteries
Functions	LEMS: Storeroom (80) LEMB and LEMD selectable: Storeroom (80), Office (50), Apartment (60) or Privacy (40)
Communication	2.4 GHz Wi-Fi® (IEEE 802.11b/g/n) Bluetooth low energy (version 4.2)
Request to Exit	Integrated into chassis
Door position sensor	Integrated in chassis for LEMS and LEMB, separate from chassis for LEMD
Tamper sensor	Integrated interior cover tamper
Temperature range	Exterior temperature: -31° to 151°F (-35° to 66°C) Interior temperature: 32° to 120°F (0° to 49°C) (battery) Humidity: 0 - 100% non-condensing
Warranty	
	1 year wireless electronic
Certifications	
ANSI/BHMA	ANSI/BHMA A156.25-2013 (indoor/locked outdoor) ANSI/BHMA A156.13-2017 Series 1000, Grade 1 Operational and Security With FSIC interchangeable core cylinders: Grade 2 Security With SFIC interchangeable core cylinders: Grade 3 Security ASTM F476-76 Grade 40
ICC	Complies with ICC A117.1 Accessible and Usable Buildings and Facilities
UL/CUL	UL 10C and CAN/ULC-S104 3-hour Fire Listed All locks listed for A label single doors, 4' x 10' and pairs 8' x 10' Letter F and UL symbol on latch front indicate listing Electrified functions are UL/ULC Listed for single-point locking applications UL 437 Listed when using UL 437 cylinder UL 294 ULC S319
CA Fire Code	All levers with a return to door of ¹ / ₂ " (64 mm) or less comply (Formerly Title 19, California State Fire Marshal Standard)
FL Building Code	Florida Building Commission Listings
Tornado	—

KRYPTONITE ■ LCN ■  ■ STEELCRAFT ■ VON DUPRIN



www.elliottdata.com



*Local Identification, Secure Access
& Accountability Solutions Provider*

St. Louis, MO | Memphis, TN

1-888-345-8511